

ACCUNIQ

BC390

User Manual



The device bears the CE label in accordance with the provisions of Medical Device Directive 93/42/EEC.

THE PERSONS RESPONSIBLE FOR PLACING DEVICES ON THE EC MARKET UNDER MDD 93/42/EEC.



SELVAS Healthcare, Inc.
155, Sinseong-ro, Yuseong-gu, Daejeon, 34109 Republic of Korea
TEL: +82 42 879 3000, FAX: +82 42 864 4462



Obelis s.a.
Bd. Général Wahis, 53, B-1030, Brussels, Belgium

TABLE OF CONTENTS

TABLE OF CONTENTS	3	Results.....	32
INTRODUCTION	4	Communication.....	32
Intended Use	4	Weight.....	33
Contraindications	4	Management Options.....	33
Word Definitons	5	Display.....	34
Classification and Compliance	5	Customer Support.....	34
Safety Symbols and Information	6	MEASUREMENT AND ANALYSIS	35
Safety Precautions	8	Precautions for Measurement	35
Guidance for Electromagnetic Compatibility (EMC).....	12	Correct Measuring Posture	36
ABOUT BODY COMPOSITION	13	How to Stand on a Scale With a Foot	
SAFETY MANAGEMENT	15	Electrode.....	36
NAME AND FUNCTION OF EACH PART	17	How to Hold the Hand Electrode	36
Main Components	17	Correct Measuring Posture.....	37
Options	18	Measurement.....	38
Device Appearance	20	Basic Analysis.....	38
Front Part	20	View Results.....	41
Base Part	20	Logging in and taking measurements with the	
Rear Part.....	21	ACCUNIQ Connect app.....	42
INSTALLATION	22	To install ACCUNIQ Connect	42
Power Connection.....	22	Loading information into ACCUNIQ Connect..	43
External Connection.....	22	Analysis Using the Ultrasonic Height Meter....	44
PC Connection – Wired (USB Cable).....	23	Analysis Using a Blood Pressure Monitor....	45
PC Connection – Wireless (Bluetooth).....	23	STORAGE AND MAINTENANCE	46
How to Connect Printer	24	PROBLEM SOLVING	47
Blood Pressure Monitor Connection	25	Error Occurrence and Actions.....	47
How to Replace Thermal Paper in the		Error Code Occurrence & Actions	48
Thermal Printer	26	Problems in Use	48
SYSTEM SETUP	28	Measurement Error Occurrence and Actions	49
Enter the ‘System Setup’ Screen	28	Packing and Transportation.....	49
Type.....	28	SPECIFICATIONS	50
Setup	30	Blood Pressure Monitor	52
Basic Settings	30	WARRANTY	53
Data Management.....	31		
Printer / Printing.....	31		

INTRODUCTION

You are kindly requested to be familiar with these directions before using this device and always keep it together with the device. In case you are not sure about any directions or problems arising while using the device, please contact with SELVAS Healthcare or its local distributor where is purchased. We will provide you with detailed instructions.

INTENDED USE

This device measures impedance by bioelectrical impedance analysis method and provides lots of information using measured impedance and inputted personal data (height, age, gender, weight).

It shows body composition of MBF, LBM, SLM, SMM, TBW, protein mass, mineral mass, etc. and information regarding BMI, PBF, BMR, abdominal analysis, Target to control, segmental analysis, Body composition change, etc.

Intended application location is professional healthcare facility environments, not home healthcare environment.

CONTRAINDICATIONS

The device should not be used in following people:

- Anyone who implants metallic materials like a pacemaker, defibrillator, stent, and metal suture in the heart and great vessel etc.
- Anyone who is equipped with the devices injecting electric current such as artificial heart, and heart lung machine.
- Anyone who is connected to liquid-filled catheter and other electronic devices of good conductivity.
- Anyone who use following device can go into danger or cannot reach objective result due to interference with other electric signals.

Using electronic stimulator for various purposes.

- Devices injecting electric current or connecting and operating: ECG, EMG, and EEG.
- Any other person who is diagnosed by the doctor to be influenced even by imperceptible micro-current.

Please consult with doctor before using this device to:

- Any woman with contraceptive devices.
- Any woman in pregnancy.

WORD DEFINITIONS

To ensure safe operation and long term performance stability, it is essential that you fully understand the functions, operating and maintenance instructions by reading this manual before operating your unit.

Particular attention must be paid to all warnings, cautions and notes incorporated herein.

The following conventions are used throughout the manual to denote information of special emphasis.



Warning

“Warning” indicates important information about the presence of a hazard which may cause severe personal injury, loss of substantial property, damage if the warning is ignored.



Caution

“Caution” indicates important information about the presence of a hazard which may cause minor personal injury or property damage if the caution is ignored.



Note

“Note” indicates important information in order to notify installation, operation or maintenance of this device. “Note” is important but not hazard-related. Hazard warnings are not included here.

CLASSIFICATION AND COMPLIANCE

1) This device is classified as;











- Class 1 type-BF against electric shock
- Ordinary equipment without protection against ingress of water
- Equipment not suitable for use in presence of a flammable anesthetic mixture by standard of IEC 60601-1:2005/A2:2020 (Basic safety and essential performance of Medical Electrical Equipment)











2) This device is complied with Class A for Noise-Emission, Level B for Noise-immunity, by standard of IEC 60601-1-2:2014(Electromagnetic Compatibility Requirements).

SAFETY SYMBOLS AND INFORMATION

The International Electro-technical Commission (IEC) has established a set of symbols for medical electrical equipment which classify a connection or warning of any potential hazard.

The classifications and symbols are shown below. Save these instructions for your safety.

SYMBOL	INFORMATION
	Degree of protection against electric shock : TYPE BF
	Please observe operating instructions
	General warning sign
	General prohibition sign
	General mandatory action sign
	Caution sign
	Waste Electrical and Electronic Equipment (WEEE) The device could be sent back to the manufacturer for recycling or proper disposal after their useful lives. Alternatively the device shall be disposed in accordance with national laws after their useful lives.
	"OFF" (only for a part of equipment)
	"ON" (only for a part of equipment)
	Direct current
	Date of manufacture

SYMBOL	INFORMATION
	Manufacturer
	CE mark
	Serial No.
	Authorized representative in the European community.
	Keep dry
	This way up
	Fragile
	Do not use blades to open
	Handle with care
	Medical Device

SAFETY PRECAUTIONS

This device is designed and manufactured with consideration of the safety of the operator and subject and also the reliability of the unit.

The following warnings, precautions and notes must be observed for safety;



Warning

During measurement of the body composition, a microcurrent of 180µA flows through the body. Individuals who have any kind of implanted active medical devices, such as pacemakers, should not use this equipment because the microcurrent can cause malfunction in the implanted device.



Warning

To prevent fire hazard, use only a correctly wired (100–240VAC) outlet, and do not use a MSO(Multiple Socket Outlet) that is not in compliance with IEC 60601–1.



Warning

To reduce the risk of electric shock or device damage, never plug-in or plug-out with wet hands.



Warning

Physically disabled persons should not attempt to take measurements alone, but instead should have their caretakers assist them in using the device.



Caution

The unit must be operated only by, or under supervision of a qualified person with our company or our distributors.



Caution

If you have experienced any trouble with the unit, switch it off immediately, and contact our company or its authorized dealer for assistance.



Caution

If you plan to connect any device from other manufacturers electrically or mechanically to the unit, contact our company or its authorized dealer for instructions before doing so.

When you connect computer or other system to the unit (RS–232C), the attached systems should be those certified by IEC 950 or equivalent standards for data processing equipment.

Configurations shall comply with the system standard IEC 60601–1:2005/A2:2020.

Everybody who connects additional equipment to the signal input part or signal output part configures a medical system by standard IEC 60601–1:2005/A2:2020.

If in doubt, consult the A/S department of local distributor.



Caution

Avoid the following environments for storage;

- Where the ambient temperature falls below –25°C or exceeds 70°C.
- Where the atmospheric pressure falls below 70kPa (700mbar) or exceeds 106kPa (1060mbar).
- Where the humidity is over 93% non–condensing.
- Where the unit is exposed to spray or splashing water.
- Where the unit is exposed to dust.
- Where the unit is exposed to water vapor.
- Where the unit is exposed to salty atmosphere.
- Where the unit is exposed to explosive gas.
- Where the unit is exposed to excessive shocks or vibrations.
- Where the angle of inclination of mounting surface exceeds 10 degrees.
- Where the unit is exposed to direct sunlight.



Caution

This device needs special precautions regarding EMC and needs to be installed and put into service according to the EMC information provided in the ACCOMPANYING DOCUMENTS.



Caution

Cross contamination is possible because this equipment is used with bare hands and feet. Refer to the cleaning and disinfecting methods in this manual.



Caution

Measurements may be impaired if this device is used near televisions, microwave ovens, X–ray equipment or other devices with strong electrical fields. To prevent such interference, use the meter at a sufficient distance from such devices or turn them off.



Prohibition

Do not disassemble or alter the device under any circumstances, as this could result in electric shock or injury as well as adversely affect the precision of measurements. This device is specified as Class 1 type BF unit under the standard IEC 60601–1:2005/A2:2020 (Basic safety and essential performance of Medical Electrical Equipment). Therefore, patients must not touch or handle inner side of the system at any time.



Prohibition

Do not to touch signal input, signal output or other connectors, and the patient simultaneously.

**Prohibition**

The unit has previously been adjusted in the factory for optimum performance. Do not attempt to adjust switches or any other things except those specified in this manual for operation.

**Prohibition**

Never pour any liquid directly on the scale platform, as it may leak and cause internal damage.

**Prohibition**

Never jump on the Weighing Platform, there may be a risk of stumbling and malfunction of the equipment.

**Note**

This equipment has been tested and found to comply with the limits for medical devices according to IEC 60601-1-2:2014. These limits are designed to provide reasonable protection against harmful interference in a typical medical installation. This equipment generates uses and can radiate radio frequency energy and, if not installed and used in accordance with the instructions, may cause harmful interference to other devices in the vicinity. However, there is no guarantee that interference will not occur in a particular installation. If this equipment does cause harmful interference to other devices, which can be determined by turning the equipment off and on, the user is encouraged to try to correct the interference by one or more of the following measures:

- Reorient or relocate the receiving device.
- Increase the separation between the equipment.
- Connect the equipment into an outlet on a circuit different from that to which the other device(s) are connected.
- Consult the manufacturer or field service technician for help.

**Note**

Place the Weighing Platform on a level and stable surface. If the equipment is used when the Weighing Platform is unstable because not all feet are on the surface, there may be a risk of stumbling or inaccurate measurement.

**Note**

Note that portable and mobile RF communications equipment can affect MEDICAL ELECTRICAL EQUIPMENT.

**Note**

Consult a physician or a trained health professional for interpretation of measurement results.

**Note**

In case of patients who have certain diseases, the estimates might be different

**Note**

Incorrect operation or failure of user to maintain the unit spares the manufacturer or his agent of the responsibility for system's non-compliance with specifications or responsibility for any damage or injury.

This manual is made for informational purposes and this manual and device are not meant to be a substitute for the advice provided by your own physician or other medical expert. You should not use the information contained in the device for diagnosis or treatment of health problems or prescription of medication by yourself. If you have or suspect that you have a medical problem, consult with your physician promptly.

Defective units or accessories must be packed in the replacement cartons to be shipped off from you to our company.

Shipping and insurance costs for return of defective unit must be prepaid by the users.

**Warning**

Do not modify this equipment without authorization of the manufacturer.

**Warning**

Connect the earth placed on the backside of this device to terminal plate to prevent any electric shock from leakage current or a potential difference.

**Warning**

To avoid the risk of electric shock, this equipment must only be connected to supply mains with protective earth.

**Caution**

Do not put anything other than the main unit and SELVAS's Blood Pressure Monitor within 1.5 m from the patient.

**Caution**

Do not touch any other devices other than those specified by the manufacturer.

**Caution**

Any serious incident that has occurred in relation to the device should be reported to the manufacturer and the competent authority of the Member State in which the user and/or patient is established.

Guidance for Electromagnetic compatibility (EMC)

Use of this equipment adjacent to or stacked with other equipment should be avoided because it could result in improper operation. If such use is necessary, this equipment and the other equipment should be observed to verify that they are operating normally.

Use of accessories, transducers and cables other than those specified or provided by the manufacturer of this equipment could result in increased electromagnetic emissions or decreased electromagnetic immunity of this equipment and result in improper operation.

Portable RF communications equipment (including peripherals such as antenna cables and external antennas) should be used no closer than 30cm (12inches) to any part of this equipment, including cables specified by the manufacturer. Otherwise, degradation of the performance of this equipment could result.

Details about the electromagnetic compatibility (EMC) of the ACCUNIQ BC390 are given below.

Before using the ACCUNIQ BC390, be sure to read and understand the following information.

1) Guidance and manufacturer's declaration – electromagnetic emissions

The ACCUNIQ BC390 is intended for use in the electromagnetic environment specified IEC 60601–1–2:2014 (Fourth Edition).

2) Guidance and manufacturer's declaration – electromagnetic immunity

The ACCUNIQ BC390 is intended for use in the electromagnetic environment specified IEC 60601–1–2:2014 (Fourth Edition).

3) Guidance and manufacturer's declaration – electromagnetic immunity 2

The ACCUNIQ BC390 is intended for use in the electromagnetic environment specified IEC 60601–1–2:2014 (Fourth Edition).

4) Recommended separation distances between portable and mobile RF communications equipment and the ACCUNIQ BC390

The ACCUNIQ BC390 is intended for use in the electromagnetic environment specified IEC 60601–1–2:2014 (Fourth Edition).

ABOUT BODY COMPOSITION

What is the body composition?

The body composition of human body consists of moisture, protein, fat, and minerals in a certain ratio.

Total Body Water exists inside and outside the cell at the boundary of the cell membrane, and is regulated and maintained within a certain range. Protein is a component that mainly forms the muscle layer with water and is distributed throughout the whole body, including the extremities and intestines.

Lean fat mass is the sum of the body's non-fat components, that is, Soft Lean mass and bone mineral mass. Fat Mass is stored in the subcutaneous and abdominal organs. It is decomposed and used as energy for normal physiological functions. However, excess Fat mass can accumulate in the body and cause obesity.

A healthy person maintains a certain ratio of these body components, but conversely, an unhealthy person may have an imbalance among body components, causing obesity, nutritional deficiencies, and osteoporosis.

What is obesity?

Several methods are used to diagnose obesity, the key to determining the degree of obesity is the amount of Fat Mass. In general, obesity can be divided into 'apparent obesity', which is overweight compared to height, and 'hidden obesity', which has a high amount or ratio of Fat Mass. Therefore, although simple obesity evaluation is possible through Body mass index (BMI), but percentage of body fat measured using an impedance body fat analyzer can help for a more accurate diagnosis of obesity.

Necessity for body composition analysis

We can maintain a healthy body when human body components are harmonious and balanced, and the imbalance in the amount and distribution of those components may be related to various diseases.

Impedance body fat analyzer is a device used for the purpose of analyzing the body composition constituting the human body to understand the basic health condition and to prepare in advance against harmful factors on health, which is one of the basic screening tools applied to the prevention and treatment of diseases.

Indicator for obesity judgment

- Percentage of Body Fat (%): It is the ratio of body fat to body weight. Finds the invisible obesity.
- Body Mass Index (kg/m²): Result of dividing weight by the square of height Has a strong relationship with disease morbidity.
- Obesity Degree (%): It is a value indicating the degree of obesity of the current weight compared to the standard weight.

Abdominal obesity

It is important not only to evaluate how much fat is accumulated in the body, such as percentage of body fat or fat mass, but also to evaluate where in the body it is accumulated. Fat Mass is divided into subcutaneous fat (stored under the skin) and visceral fat (stored between organs) according to the location where it is accumulated.

WHR is the ratio of waist circumference to hip circumference, so it determines the body shape.

Segmental analysis

This device measures and evaluates body fat mass and soft lean mass in 5 segments of the right arm, left arm, right leg, left leg, and trunk. Because the human body does not always maintain the correct symmetry, rather than questioning the slight difference, use it to evaluate how efficiently and positively you achieve your goal by exercise rehabilitation treatment for increasing muscle strength or muscle mass based on the initial analysis value.

Body type

About 20 types of body shapes can be derived from body weight, skeletal muscle mass, and body fat mass, and it determines the body shape closest to the user.

Biological age

It is the biological age considered according to the gender, actual age, and body composition results.

Even if the body composition of all measured people is included in the normal range, it cannot be assumed that their conditions are all the same. Therefore, the biological age is determined by further subdividing the criteria for the body composition, which can be used as a reference for physical health level.

SAFETY MANAGEMENT

This device is manufactured according to international standards, and user safety and device reliability can be guaranteed only when the following precautions are observed.

- 1) The inside of this device can only be operated by a specialist who has been trained on the function and structure of the device and has been certified by the manufacturer. Therefore, the user must not arbitrarily manipulate the inside of the device under any circumstances, and the company shall not be responsible for damage to the device, electric shock, fire, Etc.
- 2) This device was set to operate in an optimal state.
You shall not attempt to adjust any controls or switches other than those specified in the user manual. If you want to make a change, please request a service from us or a designated vendor.
- 3) If any problem occurs with the device, turn off the power immediately and contact us or a designated vendor for assistance.
- 4) Do not use or store this device in the following environments:
 - Storage in a place where the ambient temperature is out of $-25^{\circ}\text{C}\sim 70^{\circ}\text{C}$
 - Use in a place where the ambient temperature is out of $5^{\circ}\text{C}\sim 40^{\circ}\text{C}$
 - A place where atmospheric pressure is below 70 kPa (700 mbar) or above 106 kPa (1060 mbar)
 - Use in a place where humidity is less than 15% or more than 93%, and store in a place where humidity is more than 93%
 - A place where the device is exposed to water vapor or water
 - A place where the device is exposed to dust
 - A place where the device is exposed to high concentrations of oil vapors
 - A place where the device is exposed to a salty atmosphere
 - A place where the device is exposed to an explosion hazard of gas or dust
 - A place where the device is exposed to excessive shock or vibration
 - A place where the surface inclination angle is more than 10°
 - A place where the device is exposed to direct sunlight
- 5) Be sure to use this device in a grounded state. When grounding, be careful not to come into contact with anything that may cause electrical problems, such as gas, water pipes, lightning rods, and telephone lines.
- 6) Power must be supplied using the adapter provided by our company, and power supply accessories such as wires and plugs must be free from defects and meet the specifications.
- 7) Be sure to turn off the main power switch before unplugging the power cord.
- 8) Do not operate the device with wet hands.
- 9) When using the main body in connection with options or peripherals, first turn off the power of the main device. If you connect a wire while the power is on, an electric shock will occur to cause a breakdown.
- 10) If there are other power devices around, there is a risk of electric shock due to leakage current or potential difference on the surface of conductors for users installing the device such as doctors, nurses, assistants, etc. and customers measuring with this device, especially those who uses implantable current devices in the body or other medical or electronic devices. Connect the equipotential terminal on the back of the device to the grounding wire in the room for use.

- 11) Be sure to get inspection service before using the device that has foreign substances or has been exposed to a special environment.
- 12) When reusing a device that has not been used for a long time, check whether there is no abnormality in the appearance or function of the device before using it.
- 13) Observe other precautions for using general electric devices and the instructions specified in the user manual.

⚠ Cautions

1. Be sure to use the dedicated cable provided by the manufacturer for power supply to this device.
2. If this device is used near a television, microwave-based device, X-ray or other devices that generate a strong electric field, measurement failure may occur or reliability of the analyzed value may decrease.
So, keep a sufficient distance or turn off other devices.

ⓘ Note

1. This device meets the requirements of IEC 60601-1 (Common Standards for Electrical and Mechanical Safety for Medical Devices) and IEC 60601-1-2 (Electromagnetic Compatibility for Medical Devices).
2. When disposing of this device, it must be disposed of in accordance with the medical device regulations and the regulations of each country, so please follow the applicable procedures.

NAME AND FUNCTION OF EACH PART

Main Components

The basic configuration of this device is as follows.

① Main body	② User manual	③ Power cable and adapter
④ USB cable	⑤ M6 bolts	⑥ 4mm hexagon wrench
⑦ Body hinge cover	⑧ A4 result sheet	

※ Model or specification of accessories can be changed according to market supply and demand.
 ※ To read the user manual in the USB memory, install the Adobe Acrobat Reader program on the latest operating system. (<https://get.adobe.com/reader/>)

Options

1. Data Management Program

It is a program that allows you to manage your body composition in an easy and systematic way. It evaluates and interprets body fat measurement results in deep and easy-to-understand way, and it is highly practical as it selects only the most concise and essential contents to control body composition.

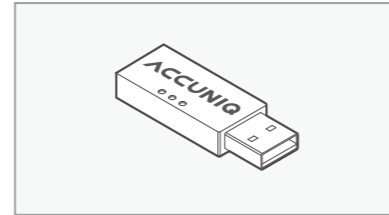

2. Result Sheet for Children

The result sheet for children is a sheet that easily displays weight, height, and growth status above BMI percentile through the child growth curve.

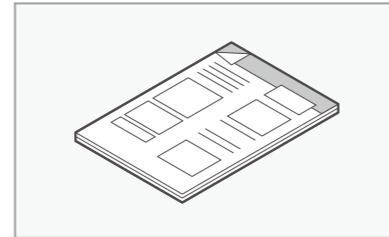

3. Automatic Blood Pressure Monitor

If Automatic Blood Pressure Monitor manufactured by SELVAS Healthcare for hospital is connected to this device, the user can easily check his/her blood pressure. Detecting the patient with hypertension may help better manage his/her blood pressure through weight control.

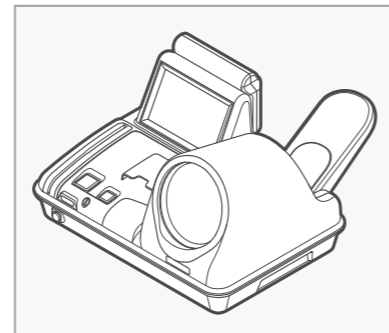

4. Thermal printer

The thermal printer enables quick and easy printing.

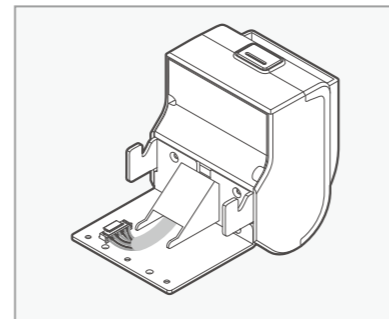

5. Thermal paper

It displays the output results in a simple and easy-to-understand way.

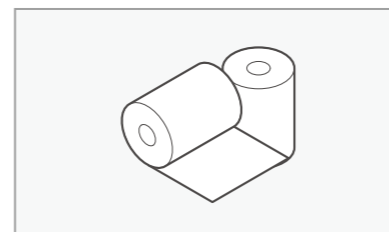

6. Bluetooth Dongle

It allows wireless communication with a PC.

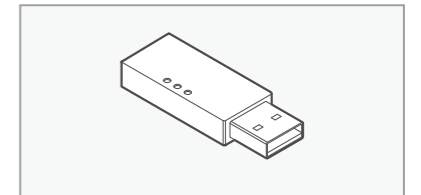

7. Ultrasonic Height Meter SM104

This is an instrument to measure subject's height more accurately and quickly. It employs standoff determination method using ultrasonic sensor.

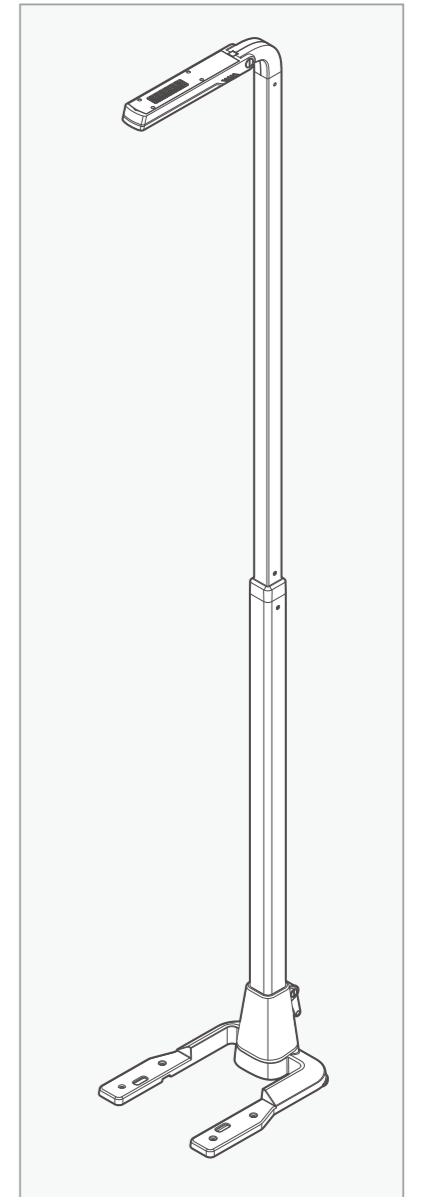

Note

The height measured in the morning is larger than the height measured in the evening, so adults may show an average of 1~2 cm difference. This is because the vertebral cartilage is maximally pressed in the evening by gravity and the person's own weight.

※ The model and specifications of the supplied accessories may be changed upon market supply and demand.



Cautions

When using commercially available thermal paper other than the thermal paper provided by us, check the specifications of 55g/m² before use. We shall not be responsible for any malfunctions caused by the use of thermal paper that does not conform to the specifications.

Device appearance

Front part

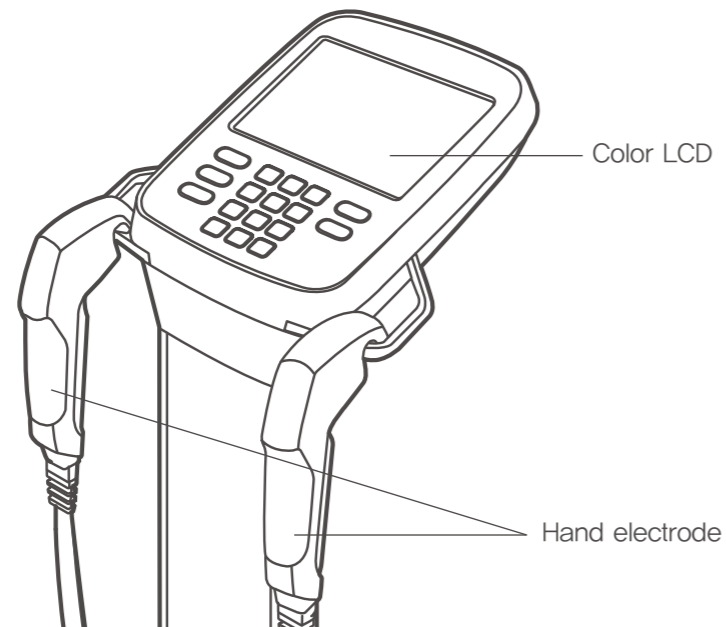

- **Color LCD (Color TFT LCD monitor):** A screen showing the input data, measurement process and results, and at the same time, it has a built-in touch screen function, where you can input data.
- **Hand electrode:** It is the part where the current input for measuring the user's resistance, the measuring device and the user's hand come into contact.

Base part

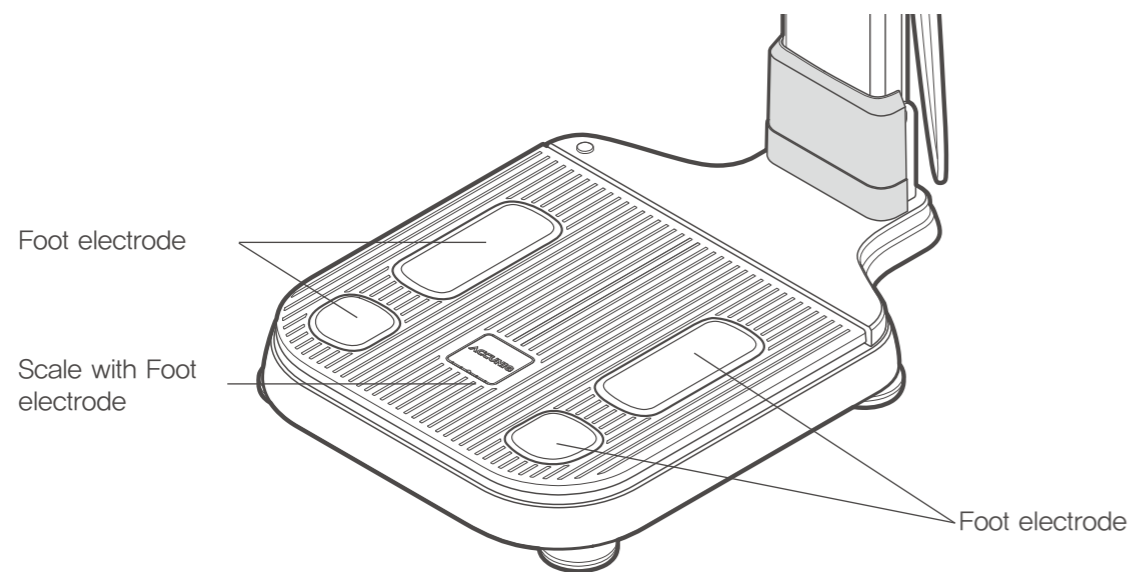

- **Scale with Foot electrode:** A scale with Foot electrode attached.
- **Foot electrode :** This electrode contacts to the user's foot to be measured. It measures the body impedance.

Rear part

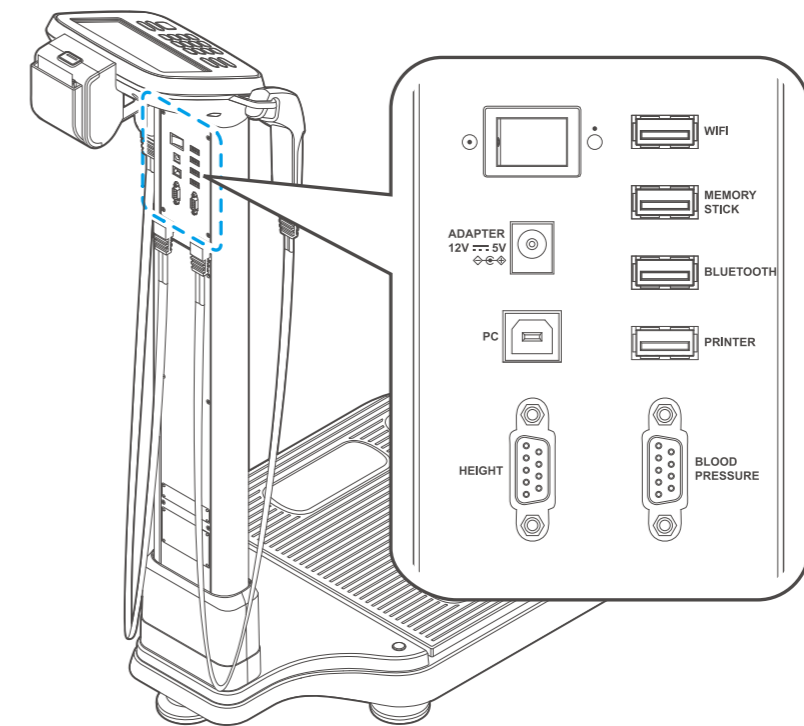

- **Power switch :** Power on/off switch
- **Adapter port :** A terminal for connecting the adapter.
- **PC Connection port:** A terminal for connecting the user's PC to device.
- **Height Meter port:** A port to connect Height Meter manufactured by SELVAS Healthcare, Inc.
- **WiFi port:** A terminal for connecting a Wi-Fi printer.
- **USB memory port :** A terminal for connecting an external memory stick
- **Bluetooth port:** A terminal for connecting Bluetooth
- **Printer port:** A terminal for connecting a printer to the device
- **Blood Pressure Monitor :** A port to connect Blood Pressure Monitor manufactured by SELVAS Healthcare, Inc.



Caution

Do not touch the patient while operating the rear panel.



Caution

Be careful for a patient not to touch the rear side during the measurement. When using a USB memory, you must use a USB memory that uses the FAT32 file system.

INSTALLATION

Power connection

- 1) Connect the adapter provided by our company to the Adapter port installed on the rear part of this device.
- 2) After connecting the wires, turn on the power switch.

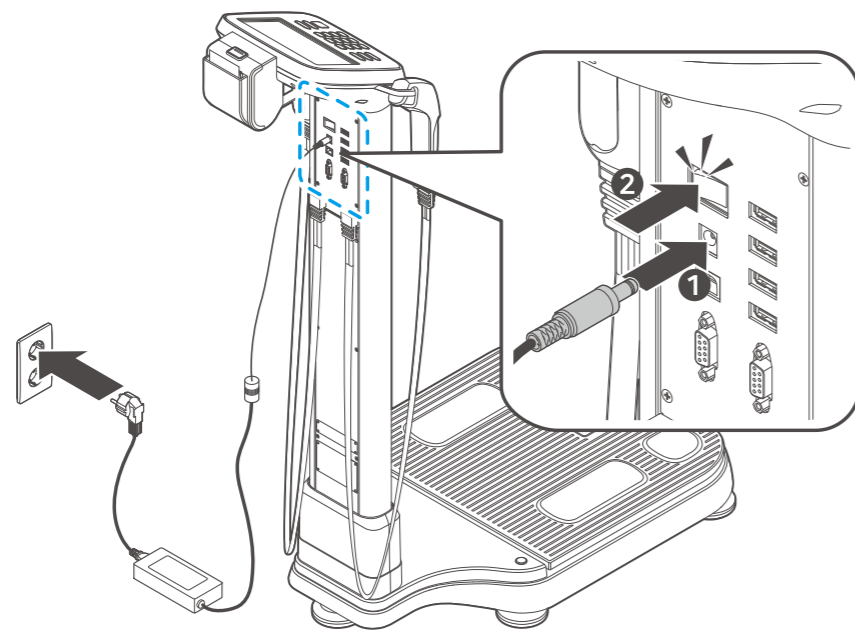

Caution

1. You must turn the power off before connecting this device to peripherals.
(An electric shock may be applied to the device, which may affect its performance.)
2. When this device and peripheral devices are connected, the power supply must start with this device to maintain the performance and safety of the device.
3. Be sure to use the adapter and cable provided by our company for power supply.
4. When turning on the device's power switch, be careful not to touch the base part where there is a scale. If weight is applied to the base part, an error occurs in the '0' point of the scale by that weight, making the weight measurement inaccurate.
5. Do not install the equipment where power can not be disconnected.

External connection



Caution

1. Connect only items that have been specified as part of the device or that have been specified as being compatible with the device
2. In the event of a cybersecurity breach, stop using the device and contact the manufacturer.
3. When using Bluetooth communication, it may be affected or may be affected by devices using other wireless systems nearby.

PC connection – Wired (USB cable)

Connect the USB (B) port on the back of the device to the computer USB port using a USB cable.

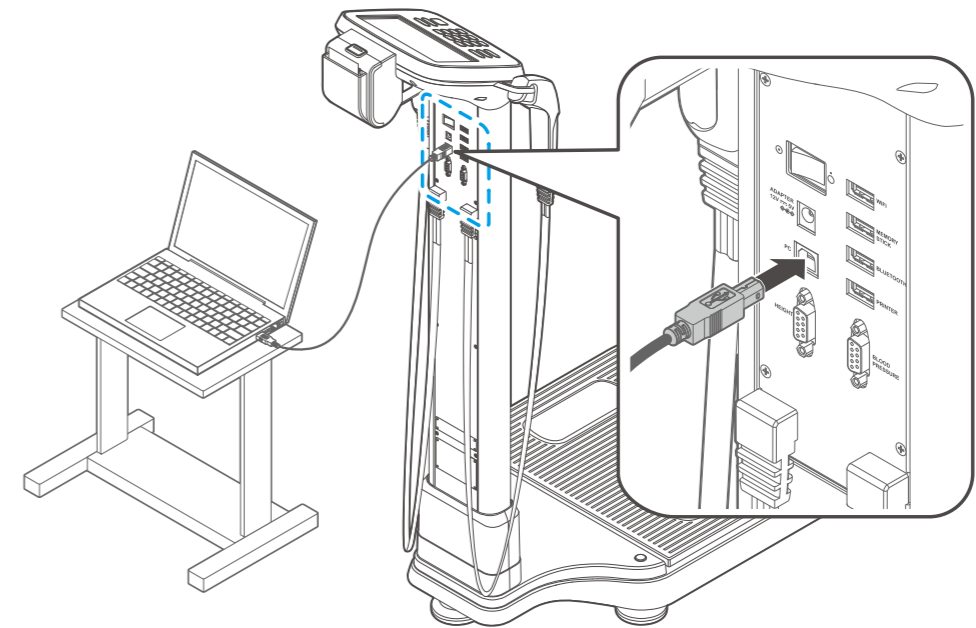

Note

1. If use USB port, the cable should be connected to the computer port.
2. When use computer port, USB driver should be installed at first.
For more information, please refer to the software user manual in the supplied USB memory.
It is recommended to use a USB cable shorter than 3m (121 inches).



Note

1. In order to save, search and retrieve the users' data, the user should connect the analyzer to the computer installed data management software offered free.
Printing is done through computer in this case.
2. The professional consulting software optionally provides various printouts.
In case of using the software, the pre-printed result sheet is not used.
3. Please refer to the software user manual in the supplied USB memory.



Caution

1. The PC that connects to the device must comply with IEC60950-1.
2. The PC must be kept up to date latest operating system for cybersecurity.
Therefore, make sure all the latest updates and security patches.

PC connection – wireless (Bluetooth)

Connect the Bluetooth Dongle provided by the company as an option to the Bluetooth terminal on the rear side of the device. Please refer to the Bluetooth Setup section of the ACCUNIQ Manager and Dashboard manual.

How to connect printer

1) How to directly connect the device–printer

Connect the A4 printer to the USB (A) port on the back of this device with a printer cable.

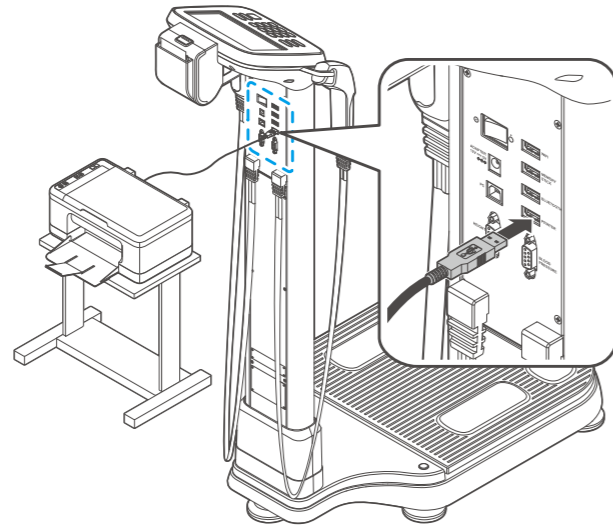

2) Connecting the device to computer–printer.

If you want to view the measurement results by connecting the A4 printer to the computer, connect it to the computer using the USB cable to the USB (B) port on the back of the device, and then connect the A4 printer provided by our company with the printer cable. Then, you can print the analysis results.

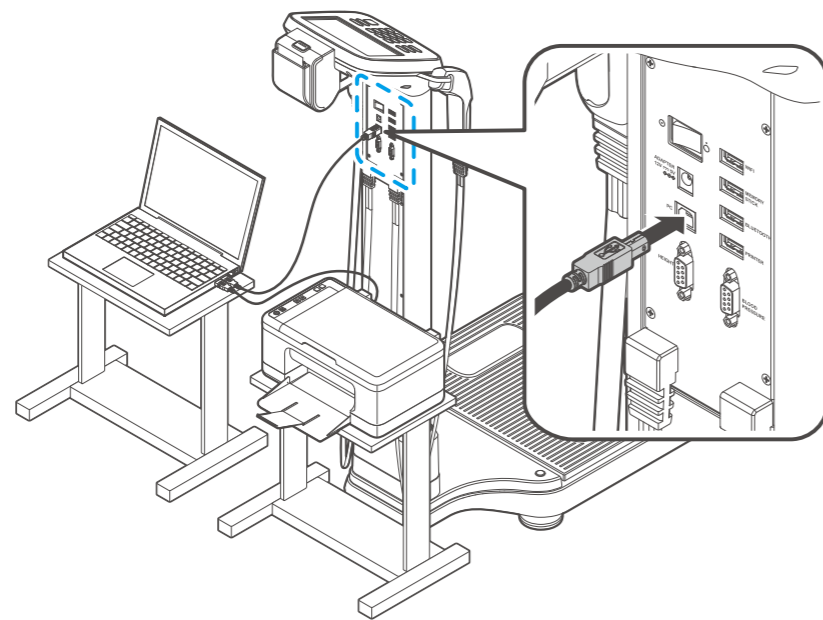

Note

1. When you want to save or search customer data using the Data Management Program provided as standard, you must connect the computer where this program is installed, and in this case, you can print through the computer.
2. If you select professional consulting software as an option, various print contents are provided, and special paper is not used in this case.
3. For information on how to install and use Windows programs, refer to the user manual built in each program.

Blood Pressure Monitor connection

This device can be connected to the autonomous Blood Pressure Monitor as an option.

Connect the Blood Pressure Monitor (RS-232C) terminal on the rear part of this device and the Blood Pressure Monitor with the provided Blood Pressure Monitor cable.

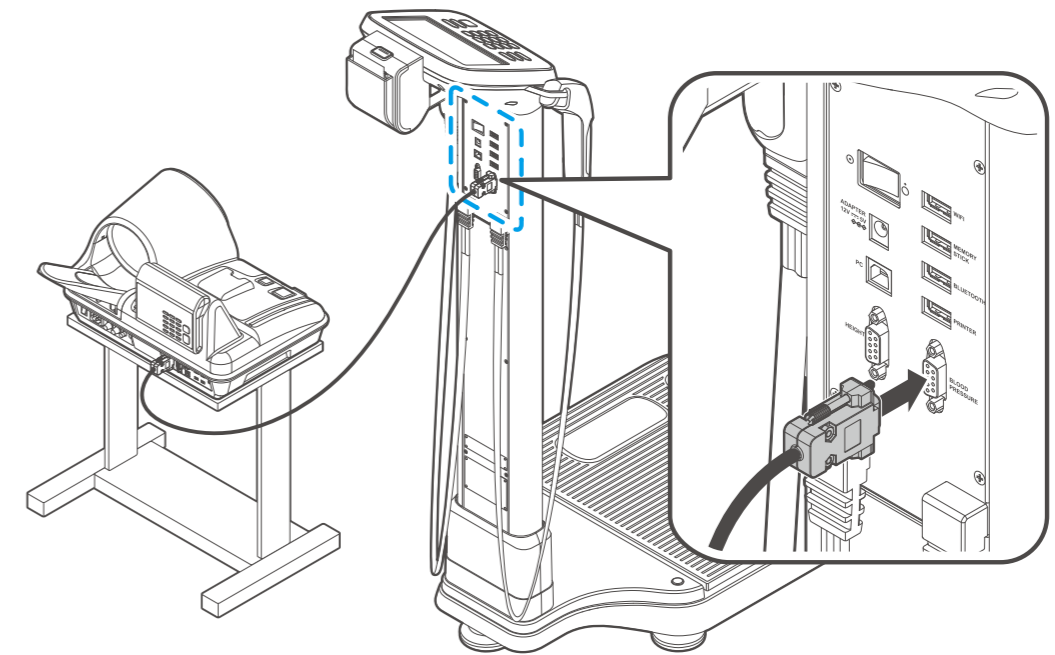

Note

For the RS-232C communication cable connecting the Blood Pressure Monitor, be sure to use the dedicated cable (within 1.5 meters) provided.

How to replace thermal paper in the thermal printer

You have to replace thermal paper while the power is on.

- 1) Open the printer cover by turning the thermal printer fixing screw counterclockwise as shown in the picture.
- 2) Remove the protective thermal paper inserted into the thermal printer by pulling it slowly in the direction of the arrow.
- 3) If you gently push the end of the thermal paper toward the printer inlet as shown in the picture, the thermal paper will be printed and the paper will be cut automatically.
- 4) Close the printer cover and fix the printer cover by turning the fixing screw clockwise.

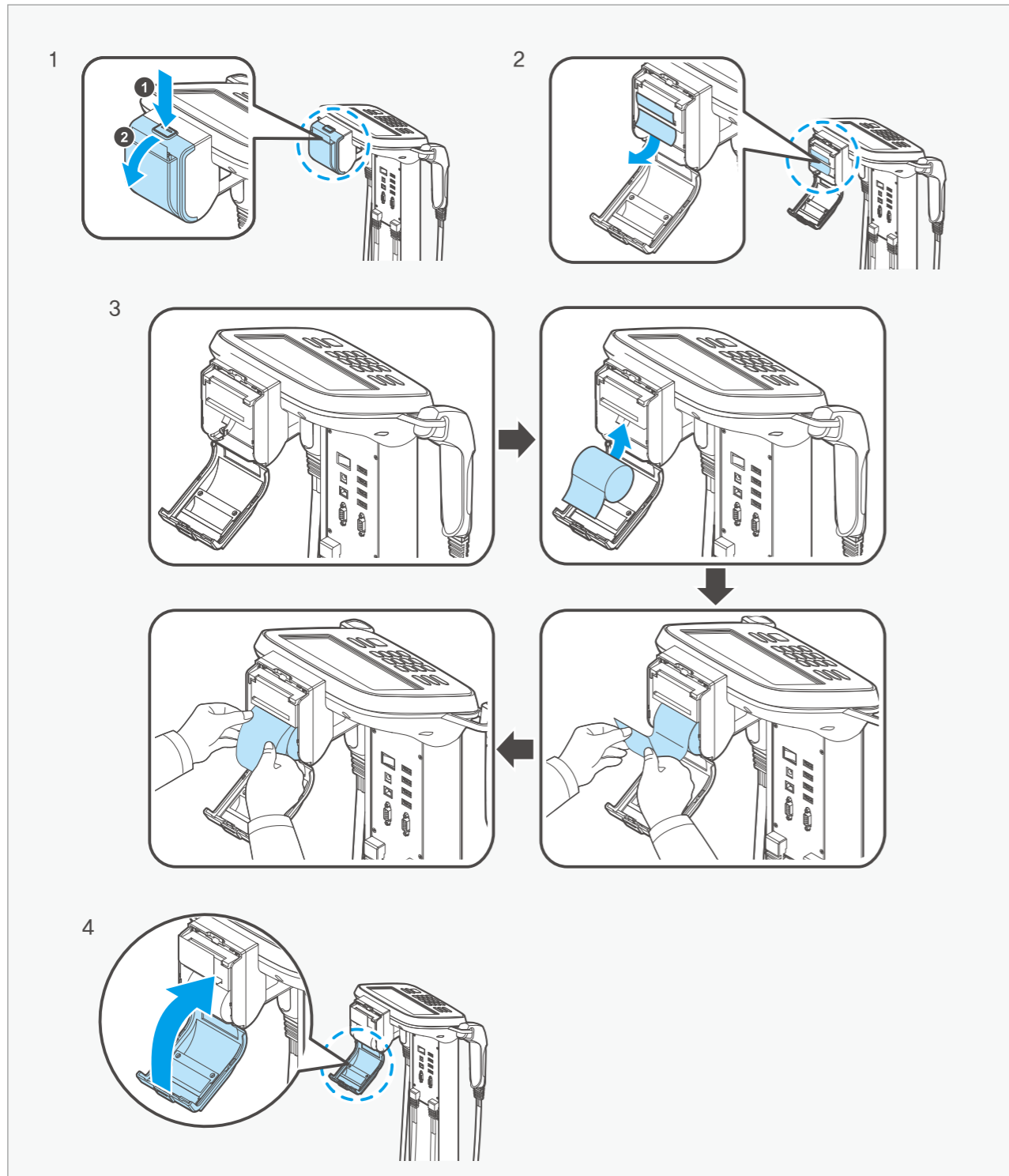

[Thermal printer FEED/CUT function]

• FEED function

If you enter the password '5555' and press 'OK' on the user setup screen, thermal paper will be printed out.

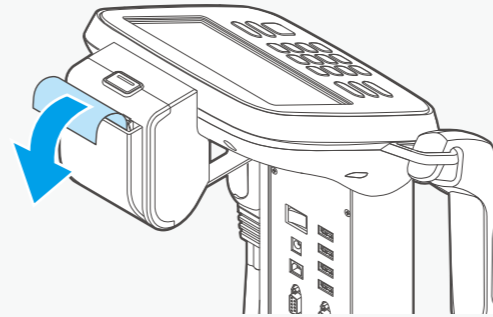

• CUT function

If you enter the password '8888' and press 'OK' on the user setup screen, thermal paper will be cut.

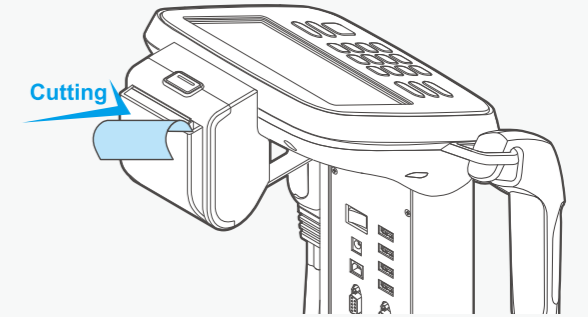

Note

Do not pull the paper during thermal paper printing. When printing is complete, the paper is automatically cut.

Operation of the device during printing may cause device failure.

SYSTEM SETUP

'User Setup' is built-in to control the operating environment of the device, so the user can set the device environment.

Note
The contents of the device's system setup are subject to change to improve performance.

Enter the 'System Setup' screen

Press the "⚙️" icon at the bottom left of the initial screen and enter the 0-0-0-0 password to enter the 'System Setup' screen.
You can change the initially set password in Basic settings-Password.



Type

The setup menu is made up of icons. The functions of each icon is as follows:

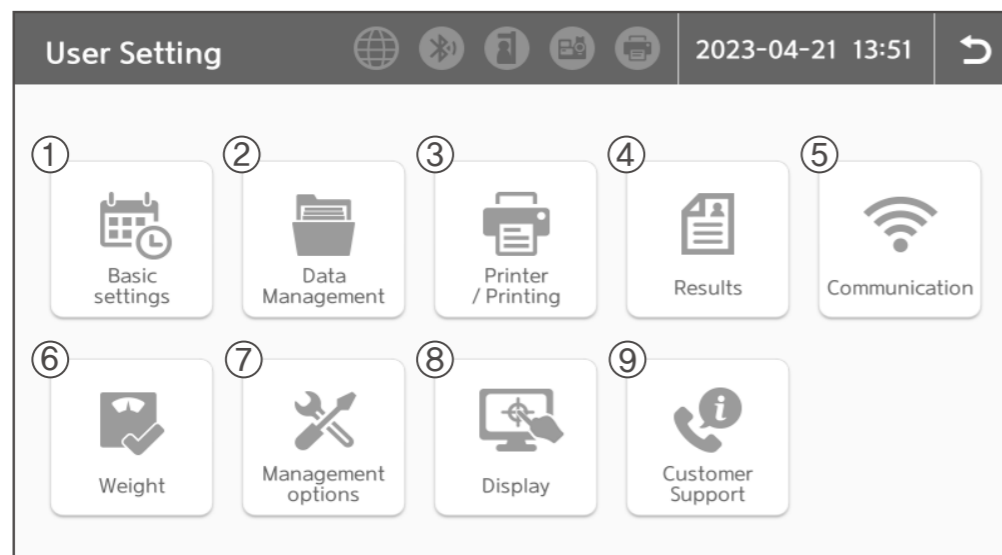

	Menu	Setup item
1	Basic settings	Date / Time
		Date format
		Select measurement unit
		Volume
		Measuring Music
		Language
		Password
		Non-member use
2	Data management	Check data / print / delete data
		Copy data to Excel file
		Data backup / restore / merge
3	Printer / Printing	Printer setup
		Set automatic printing preferences and the number of automatic prints
		Adjust print position
		Search / Connect
4	Results	ACCUNIQ exclusive paper
		Change logo
		Adult / Child outcome settings
		Abdominal obesity analysis result settings
5	Communication	Internet
		Program
6	Weight	Weight measurement / Input selection
		Weight correction
		Height correction
7	Management options	Use optional equipment
		Standard range
		Cloud Setting
8	Display	Setting Result Display For Summary
		Lock Screen
9	Customer Support	Problem solving
		Product information

Setup

Basic settings

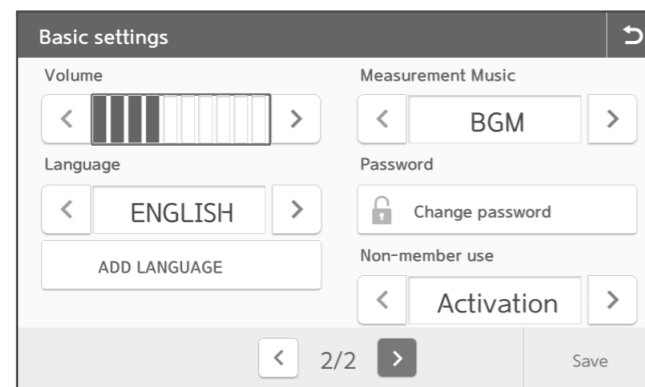
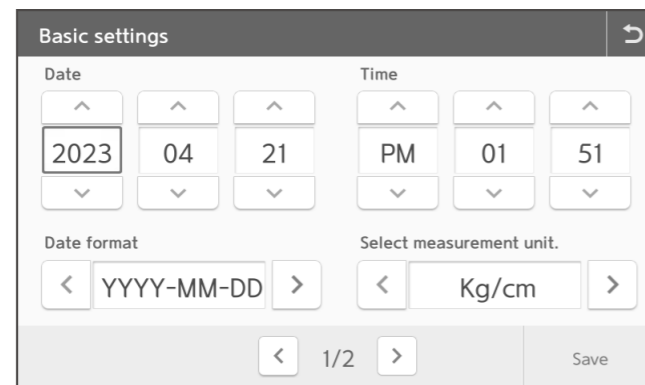

- Date/Time: Use the ^ and v buttons to set the current date and time.
- Date format: Use the < and > buttons to select the desired date format from YYYY-MM-DD, MM-DD-YYYY or DD-MM-YYYY.
- Select measurement unit: The unit of weight and height measured or entered in the Body Composition Analyzer is displayed in currently selected kg/cm.
- Volume: Set the volume of the guidance voice.
- Measuring Music: Set the background music that plays when measure body composition.
- Language: Set the displayed language.
- Password: Set the password to enter when entering user setup. The initially set password is '0000' when released. Please be careful that, if you forget your password after changing it, there is no way to find it again.
- Non-member use: Enable/disable the member function.



Note

1. If you press the 'Save' button in the middle of setting, the setup you have created to that point are input to the device and press the '↩' button to return to the previous screen.
To cancel the settings, press the '⏪' button to cancel the entered information. The settings that were originally saved are maintained.
2. When managing data using software, the 'Date/Time' set in the PC is automatically entered.

Data Management

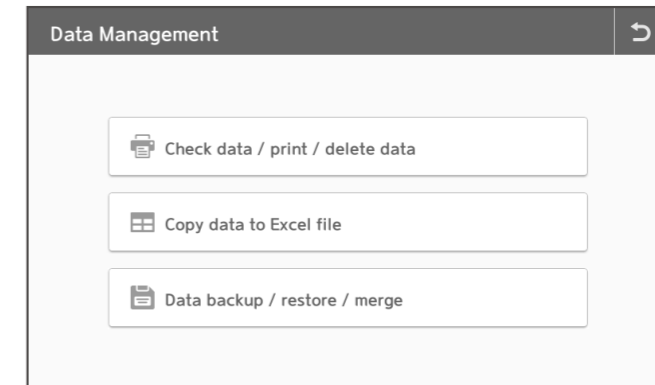

- Check data / print / delete data: You can confirm, print, or delete data saved in the device.
- Copy data to Excel file: All or part of the saved data is saved as an Excel file.
- Data backup / restore / merge: Load data files saved in USB memory to the device or save data saved in the device to USB memory.

Printer / Printing

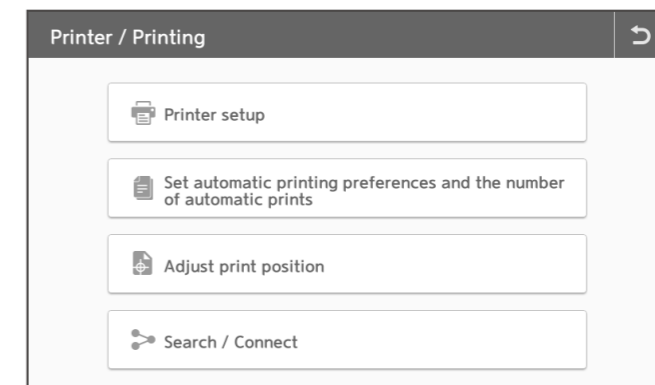

- Printer setup: Select the printer type to be connected.
- Set automatic printing preferences and the number of automatic prints: Select whether to print automatically/manually and the number of prints.
- Adjust print position: Adjust the print position when printing on special paper.
- Search / Connect: Search the connected printer to select and connect.

Results

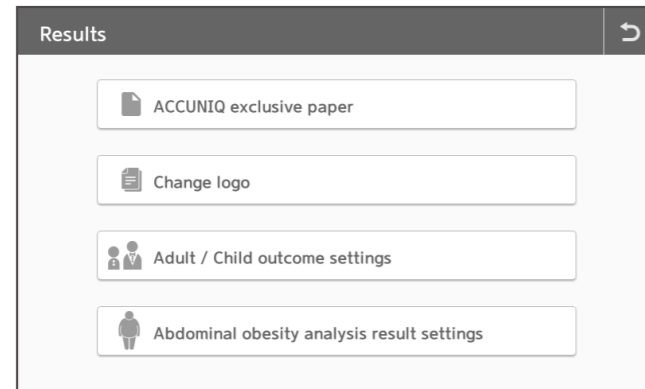

- ACCUNIQ exclusive paper: Select paper for printing the result from special paper/A4 paper.
- Change logo: Change the logo displayed on the top right of the result sheet.
- Adult / Child outcome settings: Select a result sheet for adult or child.
- Abdominal obesity analysis result settings: Select whether to evaluate abdominal obesity for children/adolescents under the age of 18.

Communication

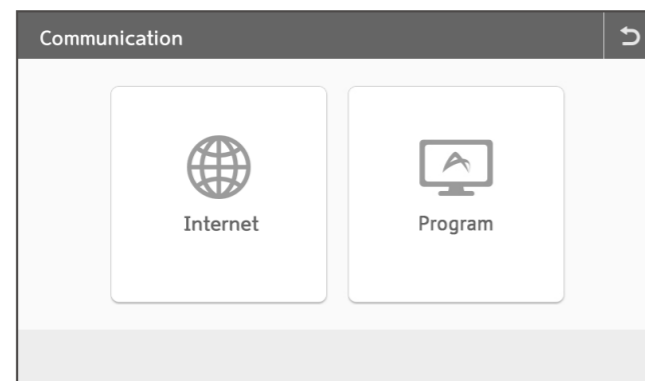

- Internet: Select the internet connection method (WiFi or Ethernet) and connect to the internet to connect your device to the ACCUNIQ cloud service.
- Program: Select communication connection method to communicate with PC. (Bluetooth or USB cable)



Note

To use ACCUNIQ Dashboard, the data management app for administrators, and ACCUNIQ Connect, the app for measurers, you must connect your measurement device to the ACCUNIQ Cloud in the Internet settings. When connected to the Internet, the device automatically connects to the ACCUNIQ Cloud and transmits measurement data.

[Internet Settings]

- 1) Connecting to the Internet via WiFi
 - Select [Connect to WiFi] from Communication > WiFi Connection.
 - When the available networks are displayed, select the network you want to use and then select the [WiFi Connection] button.
 - After entering the password, press the [OK] button to connect to WiFi.

2) Connecting to the Internet via Ethernet

- Select [Connect to Ethernet] from Communication > WiFi Connection.
- Connect an Ethernet cable to the Ethernet port labeled [PC] on the back of the device.
- Select [Obtain an IP address automatically (DHCP)] or [Set IP manually (Static)] to connect to the Internet.
- If you select [IP Manually (Static)], please enter the IPv4 address, subnet mask, and gateway DNS server information correctly.

Weight

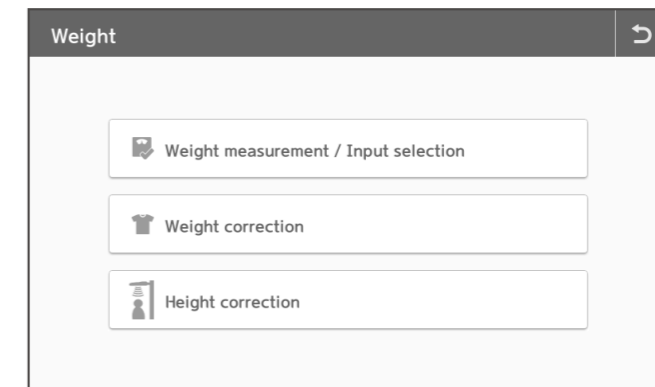

- Weight measurement / Input selection: Select whether to measure or input weight.
- Weight correction: Correct the weight value.
- Height correction: Correct the height value.

Management options

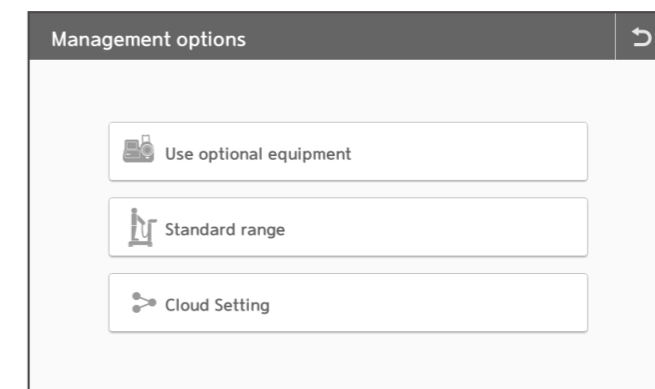

- Use optional equipment: Select a connected optional device such as a Height Meter or Blood Pressure Monitor
- Standard range: Select the adult BMI range and abdominal circumference range.
- Cloud Setting: Check the ACCUNIQ Connect server address and save the time zone as the Universal Time Coordinated (UTC) time zone of the region where you are using the device.



Note

If the time zone is set incorrectly in [Cloud Settings] > [Time Zone Settings], it may not synchronize with the server and the measurement date in ACCUNIQ Dashboard and on the device may not be correct.

Display

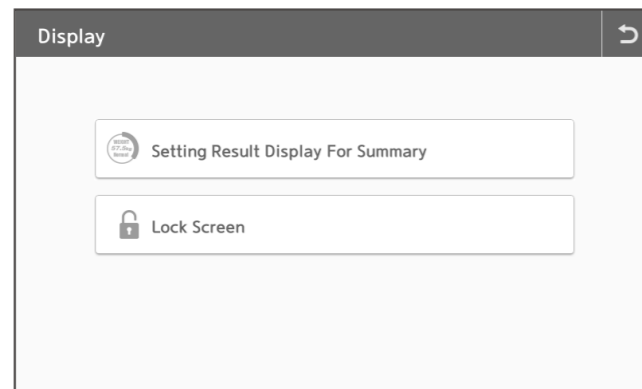

- Setting Result Display For Summary: Set summarized result display item Set the summarized result display items on the result screen.
- Lock Screen: Set the Lock Screen function.

Customer Support

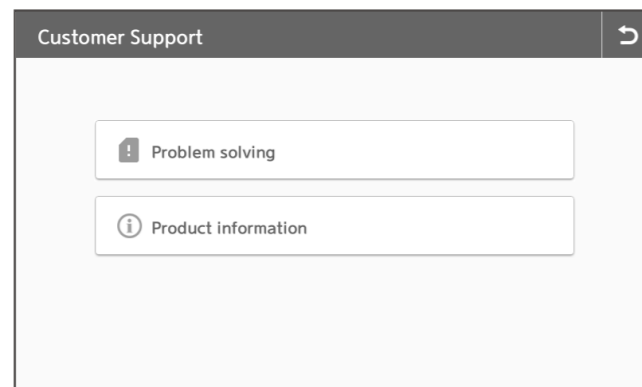

- Problem solving: You can check the cause of the problem and how to solve it.
- Product information: Check the software version of the impedance body fat scale and the serial number of the device.

MEASUREMENT AND ANALYSIS

Precautions for measurement

The reliability of the results obtained by analyzing body composition can be judged based on the accuracy. If the precision of the device, which means how much the body composition analysis value matches the actual body of the user, is called 'accuracy', the safety of the device that analyzes the same value under the same physical condition and analysis environment is called 'reproducibility'.

In order to ensure the accuracy of the analysis value, the user must comply with the following:

1. Water content increases after a meal, so measure on an empty stomach as much as possible.
 - Measure 3 to 4 hours after a meal.
 - Avoid caffeine or beverages which causes diuretic action, such as coffee, within 4 hours of measurement.
 - Drink 2 glasses of water 2 hours before the measurement.
2. Keep it stable so that the distribution of body fluid is constant before measurement.
 - Measure 3 to 4 hours after bathing, sauna, or sweaty exercise or activity.
 - Or measure before exercise or sweaty activity.
3. Do not drink alcohol for 24 hours before measurement.
4. Wear light clothing for measurement.
5. If you suddenly change your posture from a sitting position to a standing position, body water will come down to your lower body and affect the measurement. Measure after holding the standing position for 5 minutes.
6. Clean the measuring area and the electrode, and make sure that there is no foreign object between them.
7. Changes in room temperature may also affect the measurement results. At room temperature around 20°C, measure after the body's warmth has stabilized.
8. Changes in weight and body composition occur throughout the day, so measure at a fixed time. For people who stand for a long time, measuring in the morning will give more accurate analysis results.
9. Before measuring, go to the bathroom to remove as much body remnants as possible.
10. For measurements, keep the correct measurement method and posture.

In order to maintain the balance and health of body composition by examining changes in body composition through continuous body composition analysis, and comparing the results, the analysis is carried out by maintaining constant physical and environmental conditions.

In this case, it is more important to maintain the same conditions for analysis than to maintain the same conditions for the accuracy of analysis results. What is used in this case, is the reproducibility of the device. When the amount of food, the elapsed time after a meal, and the activity conditions (exercise, temperature, sauna, intake of large amounts of drinks, urination, etc.) that occur within the time affecting the analysis are kept constant, and the reproducibility of the device is secured, it means that the analysis results indicate the amount of continuous body composition change, so it can be used to evaluate the desired change in body composition.

Correct Measuring Posture

How to stand on a scale with a foot electrode

- Check whether the foot electrode or the electrode on the handle is clean.
- Remove socks or stockings when using a foot electrode.
- Remove sweat or foreign substances from your hands and body parts that will come into contact with the hand or foot electrode.
- Stand so that your feet contact the foot electrode below.
In this case, be careful not to get your pants or clothes caught between the electrodes and your feet.

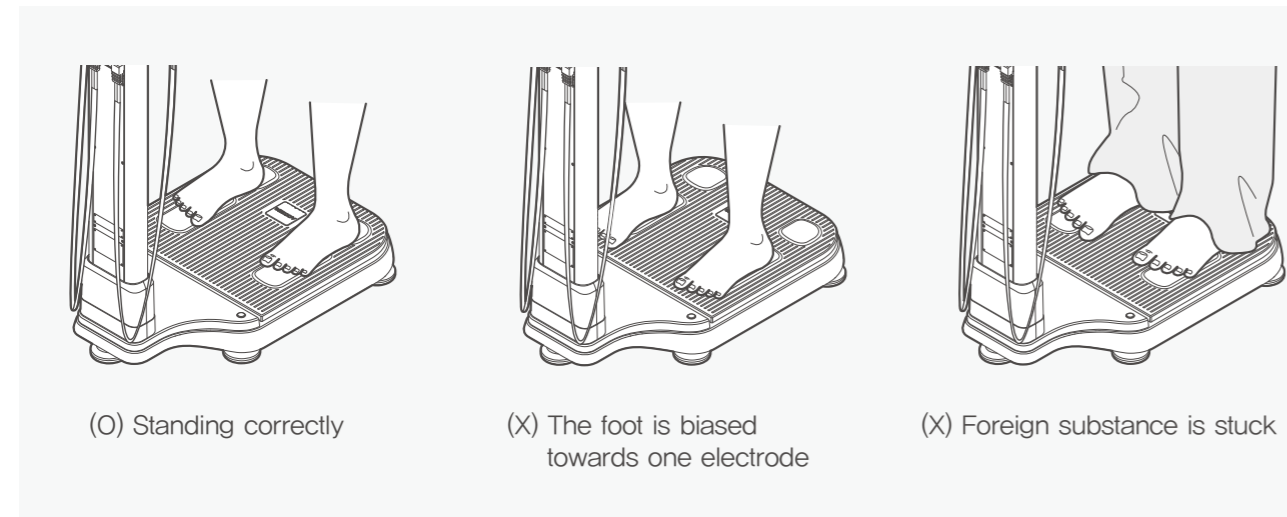

How to hold the hand electrode

- Remove sweat or foreign substances from hands.
- Hold the hand electrode so that your palm and fingers touch the entire electrode.

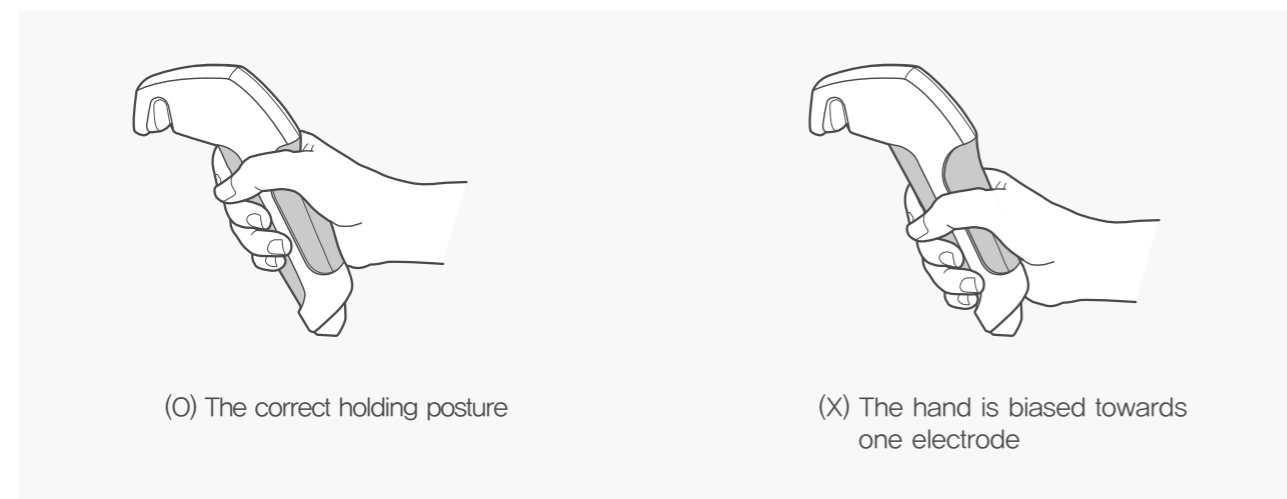

Note

If 8 electrodes are not perfectly touched during the measurement, the result is not reliable or the device quits the measurement.

1. When the subject has hands or feet that are too small to cover all electrodes sufficiently for measurement, please pay attention to touch all electrodes fairly.
How one touches electrodes will affect the reliability of the analyzed value.
2. During measurement the subject should not be touched by another person or by conductive materials.
3. If 8 electrodes are not perfectly touched during measurement, measuring is quit or the data is not reliable.

Correct measuring posture

- After stepping on the foot electrode well, hold the hand electrode correctly and keep the arm at a 30° angle to the body.
- Do not move or speak until the measurement is complete.
- If contact with the electrode is not maintained during the measurement, the measurement may be interrupted.
- Do not bend or shake your arm until the measurement is complete, remaining stationary.

Measurement

Basic analysis

If you want to measure, stand on the device's scale.

1) Measure Weight

- When you step on the scale, the screen changes with a chime bell, and the weight measurement starts. At this time, do not move or speak until the weight is completely measured, and be careful not to place your hands on other parts or lift an object while measuring on the scale.

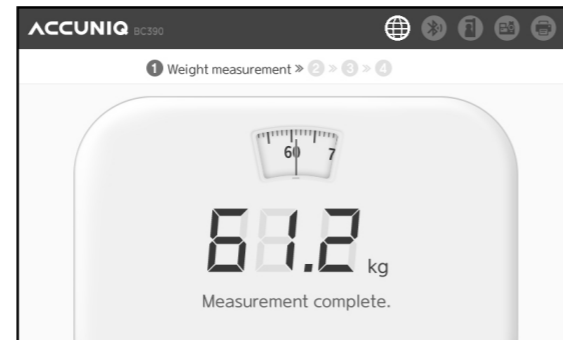

- #### 2) When the weight measurement is completed, the measurement result is displayed.
- Select either member examination or non-member examination.

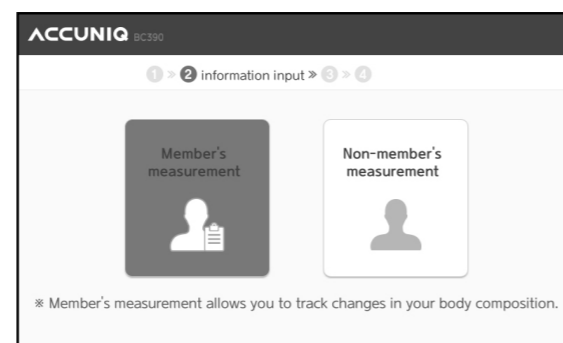

3) Enter personal information

Data required for analysis is entered in the following order: ID, height, age, and gender.

- Enter ID (for member examination)
- The 'ID' field blinks first.
- Enter your ID on the touchpad. You can enter up to 20 characters including alphanumeric characters.



- Enter your date of birth
- Enter the measurer's date of birth using the numeric keypad of the touchpad.

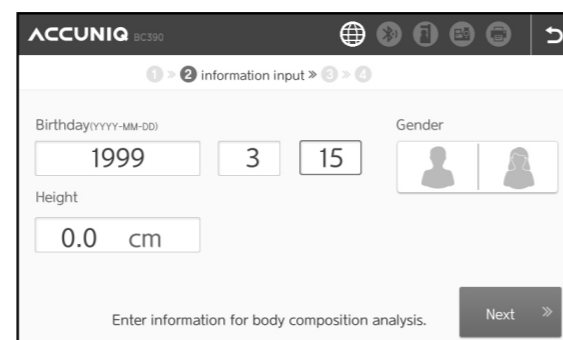

- Enter gender
- Select the gender, male or female using the touchpad.

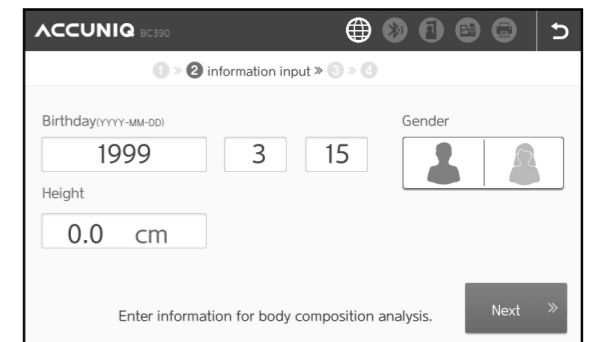

- Enter height
- Enter the height of the user using the keypad and the numeric keypad of the touchpad.
- Analysis is not possible if the height of the user is out of the input range.
- After entering it, press the 'Next' button.

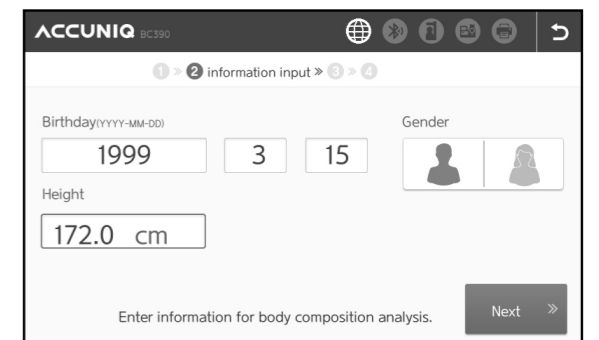

4) Start measurement – fix foot position

- Stand with your feet in contact with the foot electrode correctly.

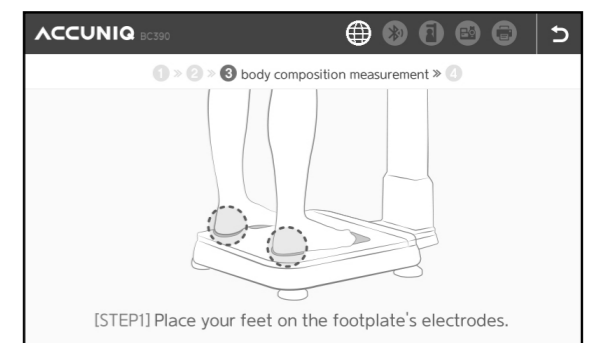

5) Start measurement – contact with the hand electrode

- Wrap and hold the hand electrode with your entire hand so that all your fingers contact with the electrode.

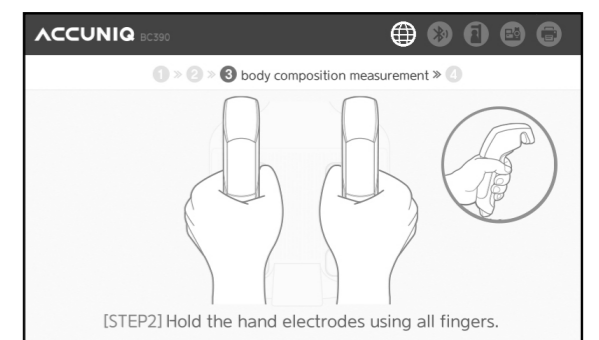

6) Start measurement – measuring posture

- Keep your arms and trunk at a 30° angle to avoid armpit contact.

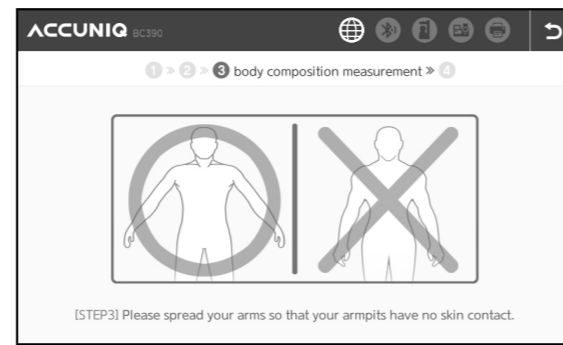
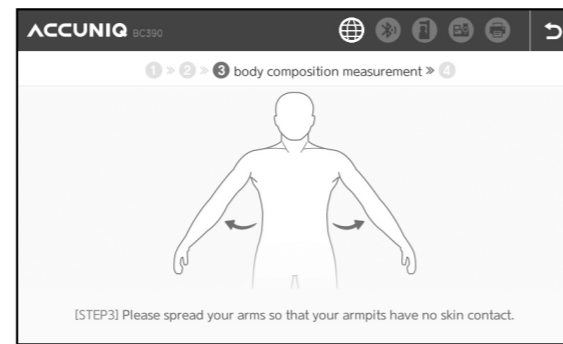

7) Start measurement

- When the measurement is completely prepared, a message “Measurement starts.”
- “Don’t speak or move.” is displayed on the screen.

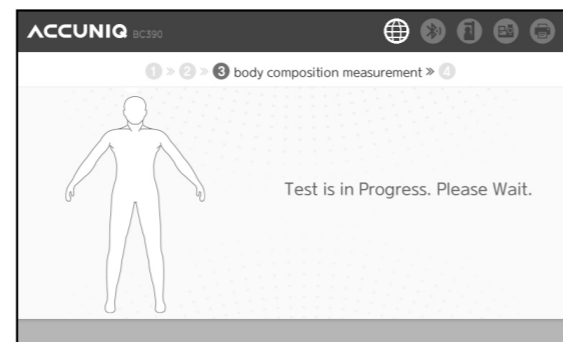

8) Measurement in progress

- When the measurement is in progress, the following screen is displayed.

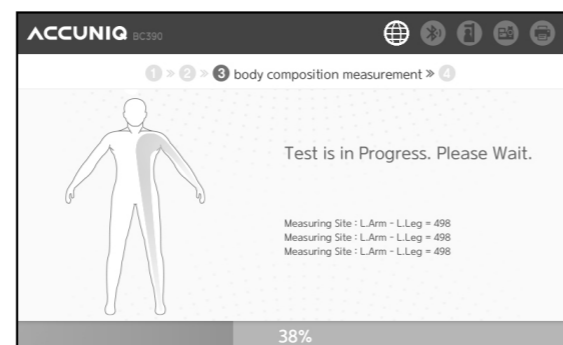

Note

- If the measurement is wrong,
- a message “Impedance is out of the measurement range” is displayed on the screen.
 - To measure again, wrap and hold the hand electrode and hold the measuring posture.
 - If a measurement error occurs 3 times in a row, the message “Measurement failed due to continuous error Please get off the scale for rest” appears on the screen Please refer to ‘Problem Solving.’

View results

1) Completing measurement and its result

When the analysis is complete, the measurement results are displayed on the screen. Analysis results consist of summarized results and view details.

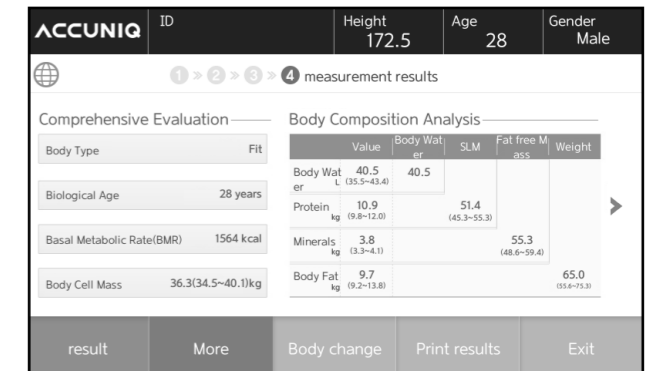

Note

If the result sheet is not printed, please check the following.

1. When the printer cable is not connected
2. When the printer power is off
3. When there is a problem with the printer (out of paper, out of ink, etc.)
4. When the print button is pressed again while printing

2) View results through a mobile device – QR code

- Pressing the QR code on the result screen, it will be enlarged and displayed on the front of the result screen.
- Recognized with the QR code reader of the mobile device, the currently measured measurement result is displayed.



Note

For QR code recognition, use the QR reader on a smart phone or tablet.

3) View results through a mobile device – App

- How to download the app Search for “ACCUNIQ Connect” in the Google or App Store, download it to install it.
- Scanning the QR code of the result in the device will send the measurement data to the app. You can check data, check accumulated data, and view results through the dedicated app. Measured data will be saved in the user's device, and expert consultation is available.

4) Restart

After checking the result, press the Exit button to return to the initial screen.

Logging in and taking measurements with the ACCUNIQ Connect app

You can save your test results to your smartphone with this dedicated app for body composition measurement record keeping.

[To install ACCUNIQ Connect]

- 1) Launch the Google Play or iOS app store and search for [ACCUNIQ Connect].
- 2) Download and install the app.
- 3) Sign up for membership.

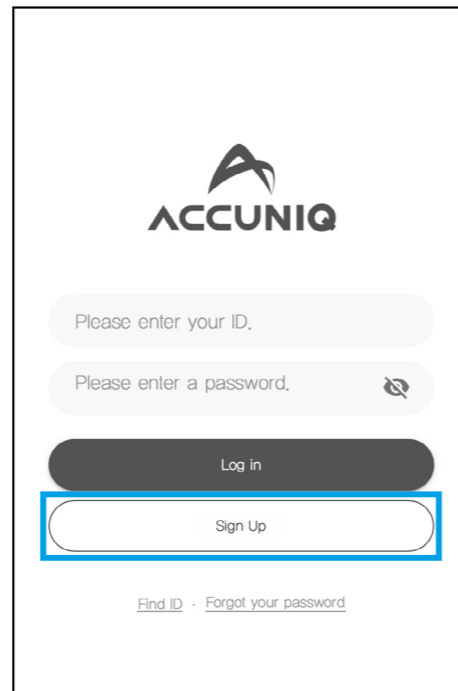
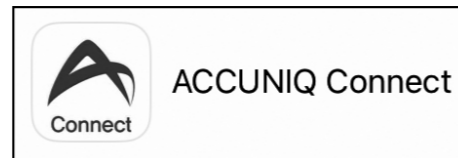

[Loading information into ACCUNIQ Connect]

- 1) Press the [Login with ACCUNIQ Connect] button on the initialization screen.



- 2) Load your information into the ACCUNIQ Connect app on your device. Scan the QR code on the right side of the screen by pressing the camera button on the top right of the [ACCUNIQ Connect App] screen on your smartphone.

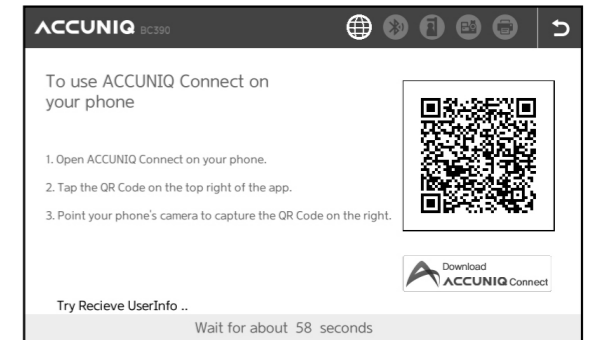

- 3) Confirm that the information imported from the app is correct and proceed with the measurement.

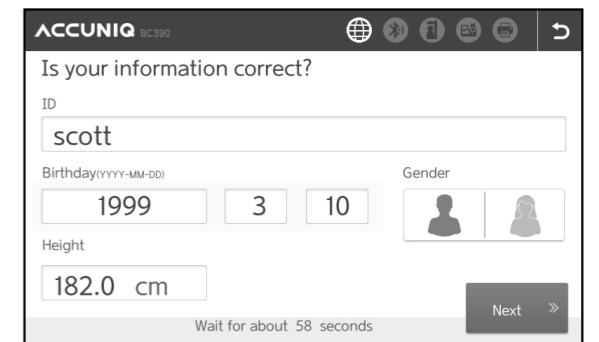

Note

1. Advantages of ACCUNIQ Connect membership:

- The membership provided by the measurement device is stored locally on that particular device, thus can be accessed only directly with the device on which you performed the measurement.
- With ACCUNIQ Connect, our personalized body composition app, your measurement data is sent to the ACCUNIQ cloud servers, where you can review your results with a professional using the administrator app (ACCUNIQ Dashboard).

2. If you select ACCUNIQ Manager from Device Settings > Communications > Programs, the [Login with ACCUNIQ Connect] button is disabled on the initial screen and the ability to log in and measure with ACCUNIQ Connect is not supported.

Analysis using the Ultrasonic Height Meter

If you select and connect an ultrasonic Height Meter as an option, you can measure the height accurately, increasing the reliability of the analysis results.

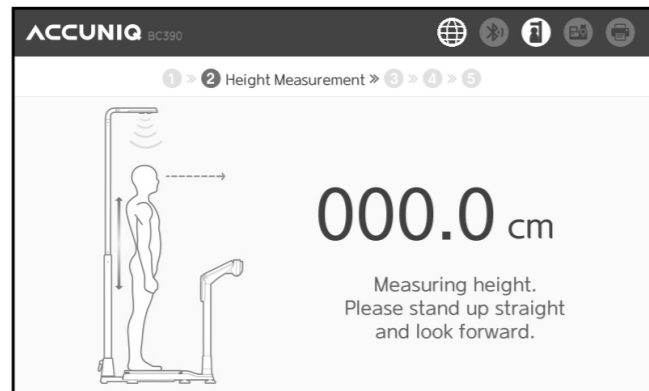

[Analysis method]

- 1) To use the height meter, connect it to the device.
- 2) Set the Use Height Meter to ON on the Setup screen.
- 3) When stepping on the scale, a message “Measure your height.” is displayed on the screen.
- 4) When the measurement is completed, the measurement results of height and weight appear on the LCD.
- 5) You can enter your personal information with a chime bell.
- 6) The height input field is converted, and after ID, age, and gender are entered, the rest proceeds in the same order as the basic analysis.



Note

When the height meter is connected, the height meter icon will light up on the standby screen. If the ultrasonic height meter is not connected, a message saying, “Height meter is not connected, move to height input mode” appears. Check the cable which connects the ultrasonic height meter to the device. If the message above appears while the ultrasonic height meter is connected, please ask us or an authorized service person for assistance.



Analysis using a Blood Pressure Monitor

It is a method to analyze body composition as well as measure blood pressure by connecting this device to a Blood Pressure Monitor. You must select our Blood Pressure Monitor for hospital use as an option.

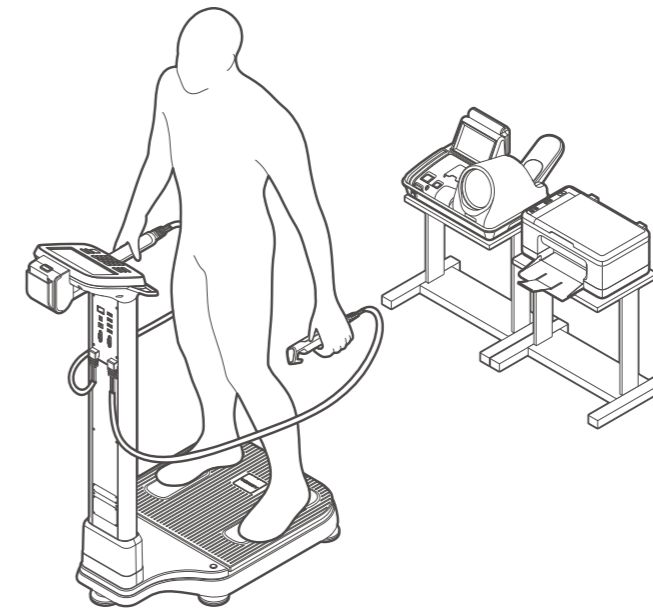

By using this method, it is possible to scientifically manage patients by linking blood pressure and obesity and presenting the effect of improving blood pressure by changes in body composition as a numerical value. The method of body composition analysis using a Blood Pressure Monitor is as follows:

- 1) Connect the Body Composition Analyzer to the Blood Pressure Monitor.
- 2) Measure your blood pressure first.
- 3) After measuring the blood pressure, analyze the body composition.
- 4) After the body composition analysis is complete, the blood pressure and the body composition analysis results are displayed on the screen.
- 5) You can check the results of body composition and blood pressure measurement on the result sheet.
- 6) You can manage the blood pressure data together by connecting to PC Manager.



Note

Before measuring body composition, a confirmation window is displayed to confirm whether to use the blood pressure measured in the connected Blood Pressure Monitor. If you select 'Yes', the blood pressure measurement result is saved after body composition measurement and the blood pressure data is displayed on the body composition result sheet. If you select 'No', the blood pressure data is not saved or displayed.

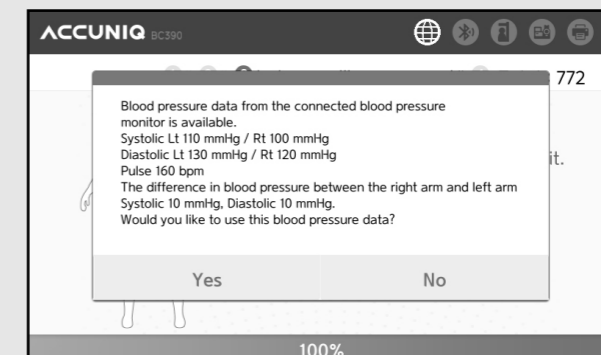

STORAGE AND MAINTENANCE

Pay attention to the allowable current value of the power supply.

Do not store in a place with direct sunlight, moisture, dust, dark oil or salt, or in locations subject to extreme temperature changes.

Do not install or store in a place where chemicals or gas are stored or where gas is generated.

Do not use in an unstable place, or in a place subject to vibration or impact.

Connect the equipotential terminal on the rear side of the device to the grounding wire in the room to prevent electric shock due to leakage current or potential difference.

Do not place objects on this device, drop it, or give strong impact to it.

Do not disassemble or modify the main body arbitrarily.

When reusing a device that has not been used for a long time, check whether there is no abnormality in the appearance or function of the device before using it.

Do not spill liquids or insert foreign substances into this device.

Be sure to get inspection service before using the device that has foreign substances or has been exposed to a special environment.

Be sure to use the power cable or adapter provided by the manufacturer.

At this time, first check whether there are no defects in the wire sheath, plug connection status, and other inspection items.

- RS 232C cable
- USB terminal
- Adapter

Turn off the power first, then pull out the plug by holding the plug properly.

If this device is used near a television, microwave-based device, X-ray or other devices that generate a strong electric field, the reliability of the measurements can be maintained only when keeping a sufficient distance or turning off the other devices, and electric shock due to leakage current or potential difference can be prevented.

Storage environment: Temperature $-25^{\circ}\text{C}\sim 70^{\circ}\text{C}$, relative humidity less than 93% (non condensing)

Operating environment: Temperature $5^{\circ}\text{C}\sim 40^{\circ}\text{C}$, relative humidity less than 15~93% (non condensing)

Do not store or use in places where the atmospheric pressure is less than 70 kPa (700 mbar) or higher than 106 kPa (1060 mbar).

Cleaning & Disinfection

- Cleaning: When cleaning, use a soft cloth but do not use volatile solvent like benzene and alcohol or a wet cloth. Wipe out minute dust once per 2~3 days with a dry cloth.
- Disinfection: Spray alcoholic water of glutaraldehyde disinfect solution. Then, wipe the enclosure with a soft lint. Please refer to and abide by the "SAFETY PRECAUTIONS."



Caution

Users must be sure to use sterile safety equipment such as gloves when in contact with or cleaning electrodes.

SELVAS Healthcare is not responsible for safety accidents caused by users' carelessness.

PROBLEM SOLVING

Error Occurrence and Actions

Error	Cause	Action
Impedance is out of measurement range.	<ul style="list-style-type: none"> • When the user's impedance is out of the measurement range • In case of poor contact with the electrode • When the impedance is lower or higher than the range • Measurement range: 100~950 Ω 	<ul style="list-style-type: none"> • Measure again after cleaning the measurement area (electrodes, hands, feet) • Measure again after correcting the electrode-holding method and measuring posture. • Do not move your body during measurement to avoid momentarily poor contact with the electrode. • If the same error is displayed on the LCD even during re-measurement, contact us or a designated vendor.
The percentage of body fat is out of the measurement range.	<ul style="list-style-type: none"> • When the user's percentage of body fat analysis result is out of the allowable range • Personal data input error • When the percentage of body fat is out of range 	<ul style="list-style-type: none"> • Measure again after wiping the hand electrode clean • If the same error is displayed on the screen even during re-measurement, contact us or a designated vendor.
When the measurement does not proceed to the next step	<ul style="list-style-type: none"> • If the user's height or age is outside the input range • Height input error • Age input error 	<ul style="list-style-type: none"> • Please enter your height and age correctly. However, you cannot enter it when it is out of the analysis range.
When the weight cannot be measured	<ul style="list-style-type: none"> • The user's weight is out of the measurement range. • Weight measurement error • Continue moving during measurement 	<ul style="list-style-type: none"> • Measure the weight again. However, it is not possible to measure the user's weight if it is out of the measurement range.
Not connected to the body fat analyzer.	<ul style="list-style-type: none"> • In case of internal communication error 	<ul style="list-style-type: none"> • Turn the power off and then on. • If the same message is displayed repeatedly, please contact us or a designated vendor.

Error Code Occurrence & Actions

Error code	Cause	Action
38001	<ul style="list-style-type: none"> Electrode and measuring parts are not detected or dirty Faulty in impedance measuring 	<ul style="list-style-type: none"> Try to measure again after cleaning the electrode holders with soft gauze Try again after cleaning the hands and soles Check if foreign materials are between electrodes and measuring parts Try again in correct posture and hold the electrodes according to the measuring method
38003	<ul style="list-style-type: none"> There is an error in measured impedance by external influence. 	<ul style="list-style-type: none"> Check installation condition (AC cord or around equipment) Contact SELVAS Healthcare or distributor
38004	<ul style="list-style-type: none"> Out of measurement range of impedance Range: 100~950Ω 	<ul style="list-style-type: none"> Try again after cleaning the hands and soles Check if foreign materials are between electrodes and measuring parts It can't measure if the impedance is out of range
38005	<ul style="list-style-type: none"> Out of measurement range of PBF range: Under 75% 	<ul style="list-style-type: none"> Try again after cleaning the hands and soles It can't measure if the PBF is out of range
38006	<ul style="list-style-type: none"> Continuous error for 3 times 	<ul style="list-style-type: none"> Step off and try again Contact SELVAS Healthcare or distributor
38007	<ul style="list-style-type: none"> Disconnect Color board and Main board 	<ul style="list-style-type: none"> Contact SELVAS Healthcare or distributor

Problems in use

If there is a problem with the device, please follow the steps below:

- Please check again according to the measurement inspection items.
If the problem persists, please contact us or a designated vendor.
- When contacting us or a designated vendor, please briefly write down the model name, serial number, date of purchase, and description of operational defect.
- We are committed to meeting the needs of our consumers.
For devices we manufacture, we have trained and skilled after-sales service technology, and if there is a problem with the device, we will promptly solve it with the best service.



Note

For our address and contact information, please refer to the back of the user manual.

Measurement Error Occurrence and Actions

Error	Cause	Action
When the percentage of body fat is measured too high or too low	<ul style="list-style-type: none"> Imbalance of water, such as immediately after exercise, after bathing, after sweating a lot, and drinking a lot of water Moving or speaking during measurement When the hand electrode, or measurement areas such as hand, foot, etc. is unclean 	<ul style="list-style-type: none"> After reading the 'Precautions for Measurement', measure again according to the measurement method. Be careful not to move or speak during measurement. Wipe the electrode part of the hand electrode with soft gauze and measure again. If your hands and feet are sweaty or dirty, wash them and measure again. Check whether there are no foreign substances between the electrode and the measurement area.
When measurement is not performed	<ul style="list-style-type: none"> Disconnection between the electrode handle and the main body, or bad contact The Start measurement button inoperative 	<ul style="list-style-type: none"> Please contact us or a designated vendor.
	<ul style="list-style-type: none"> The electrode handle is not connected to the main body. There is a problem with the electrode handle. 	<ul style="list-style-type: none"> Check whether the electrode handle is connected to the main body, and then connect it. If this problem persists even though the electrode handle is connected, contact us or a designated vendor.

Packing and Transportation

We have packed this device in the most suitable way to transport it safely. Moving or transporting in a manner other than this packaging method may result in damage to the device itself.

For packaging and transportation of the device, you must handle it with care so that the device is not subject to shocks while in its packaging.

If this device needs to be transported while in use, repack it in the following order:

- Turn off the power to this device.
- If peripheral devices are connected, power off and disconnect each device.
- Disassemble the device in the reverse order of assembling it.
- Repack it using the stored packaging material of this device.
- Transport the device with the utmost care to avoid shocks.

SPECIFICATIONS

Item	Explanation
Model	ACCUNIQ BC390
Measuring method	BIA via tetra-polar electrode method using 8 touch electrodes.
Frequency range	5, 50, 250, 550 kHz
Measurement area	Measurement of the whole body and segments (arms, legs, trunk)
Result item	<p>[Body composition result sheet]</p> <ul style="list-style-type: none"> • Body Composition Analysis: Weight, Fat-Free Mass, Fat Mass, Soft Lean Mass, Protein, Minerals, Total Body Water • Skeletal Muscle/Fat Analysis: Weight, Skeletal Muscle Mass, Fat Mass • Obesity Analysis: Body Mass Index, Percentage of Body Fat • Segmental Analysis: Soft Lean Mass / Fat Mass / Total Body Water (Left Arm, Right Arm, Left Leg, Right Leg, Trunk) • Body Water Analysis: ECW ratio, ICW, ECW • History: Weight, Skeletal Muscle Mass, Percentage of Body Fat, Total Body Water • Comprehensive Evaluation: Body Type, Biological Age, Basal Metabolic Rate, Total Daily Energy Expenditure, Obesity Degree, Total Score • Nutritional and cellular health assessment: Protein, Minerals, Body Cell Mass, Phase Angle • Body Balance Assessment: Upper Body L/R, Lower Body L/R, Body Upper-Lower • Body composition chart • Skeletal Muscle Mass Index: SMI, ASMI • Research Content: Waist Circumference, Waist to Hip Ratio, Visceral Fat Level, Visceral Fat Cross-sectional Area, Visceral Fat Mass, Body Cell Mass • Impedance (segment & frequency) • Blood Pressure Analysis <p>[Result Sheet for Children (Option)]</p> <ul style="list-style-type: none"> • Body Composition Analysis: Weight, Fat-Free Mass, Fat Mass, Soft Lean Mass, Protein, Minerals, Total Body Water • Skeletal Muscle/Fat Analysis: Weight, Skeletal Muscle Mass, Fat Mass • Obesity Analysis: Body Mass Index, Percentage of Body Fat, Waist to Hip Ratio • Comprehensive Evaluation: Body Type, Basal Metabolic Rate, Total Daily Energy Expenditure, Body Cell Mass, Obesity Degree • Body Balance Assessment: Upper Body L/R, Lower Body L/R

※ The appearance and specifications of this device and options are subject to change without notice for quality improvement.

SPECIFICATIONS

Item	Explanation
Result item	<ul style="list-style-type: none"> • Control Guide: Recommended Weigh, Weight Control, Muscle Control, Fat Control • Segmental Fat Mass : Left Arm, Right Arm, Trunk, Left Leg, Right Leg • Segmental Lean Mass: Left Arm, Right Arm, Trunk, Left Leg, Right Leg • History: Height Percentile, Weight Percentile, Body Mass Index Percentile • Height/Weight/BMI Assessment: Height, Weight, Body Mass Index • Impedance (segment & frequency)
Measured current	Within 250μA ±15
Power supply	Input-AC 100~240V~, 50/60Hz, 1.4~0.7A Output-DC 12V, 5A, 60W MAX.
Display method	7inch wide color LCD
Input device	Key pad, Touch pad
Transmission device	USB port, RS-232C, Bluetooth (Option)
Printing device	USB port (the printer assigned by SELVAS Healthcare), Thermal print (option)
Size	641×436×1029mm (W×D×H)
Weight	About 18 kg (main unit)
Measurement time	Approx. 60 seconds
Input height	50 ~ 220 cm / 1ft 7.7in ~ 7ft 2.6in
Input weight	10 ~ 250 kg / 22lb ~ 551.1lbs
Measurement age	1 ~ 99 years old
Range of use	Ambient temperature range +5 to +40°C Relative humidity range 15 to 93% (non-condensing) Atmospheric pressure range 70 kPa (700 mbar) to 106 kPa (1060 mbar)
Range of storage	Ambient temperature range -25 to +70°C Relative humidity range lower than 93% RH Atmospheric pressure range 70 kPa (700 mbar) to 106 kPa (1060 mbar)
Software name and version	Name: BC390, Version: BC390.EN.1.0.00

※ The appearance and specifications of this device and options are subject to change without notice for quality improvement.

Blood Pressure Monitor

This device can be connected to the below Automatic Blood Pressure Monitors from SELVAS Healthcare.

BP500

Item	Specifications
Manufacturer	SELVAS Healthcare, Inc.
Model	BP500
Measuring method	Oscillometric
Result Contents	Systolic/Diastolic/Mean blood pressure, Pulse pressure, Pulse, Blood pressure assessment, Pulse wave pattern
Result item	Systolic Pressure: 60 to 280 mmHg, Diastolic Pressure: 30 to 200 mmHg Pulse rate: 30 to 240 beat/minute
Accuracy	Pressure ± 2 mmHg, Pulse $\pm 1.5\%$
Resolution	1mmHg

※ The appearance and specifications of this device and options are subject to change without notice for quality improvement.

ACCUNIQ BP210

Item	Specifications
Manufacturer	SELVAS Healthcare, Inc.
Model	ACCUNIQ BP210
Measuring method	Oscillometric
Result Contents	Systolic/Diastolic/Mean blood pressure, Pulse pressure, Pulse, Blood pressure assessment, Pulse wave pattern
Result item	Pressure: 30 to 300 mmHg, Pulse rate: 30 to 200 beat/minute
Accuracy	Pressure ± 3 mmHg or $\pm 3\%$, Pulse $\pm 3\%$
Resolution	1mmHg

※ The appearance and specifications of this device and options are subject to change without notice for quality improvement.

ACCUNIQ BP250

Item	Specifications
Manufacturer	SELVAS Healthcare, Inc.
Model	ACCUNIQ BP250
Measuring method	Oscillometric
Result Contents	Systolic/Diastolic/Mean blood pressure, Pulse pressure, Pulse, Blood pressure assessment, Pulse wave pattern
Result item	Pressure: 30 to 300 mmHg, Pulse rate: 30 to 200 beat/minute
Accuracy	Pressure ± 3 mmHg or $\pm 3\%$, Pulse $\pm 3\%$
Resolution	1mmHg

※ The appearance and specifications of this device and options are subject to change without notice for quality improvement.

WARRANTY

Name of device	Body Composition Analyzer		
Name of model	ACCUNIQ BC390		
Serial number			
Period of warranty / Date of purchase	Within 1 years from the date of manufacture		
Customer	Add.	Name	
		Tel.	
Dealer (market)	Add.	Name	
		Tel.	



Note

- When you receive this warranty, make sure that the name of the dealer and the month, day and year of purchase are all completed.
- This warranty will not be reissued, please keep it in a safe place.

Periodic Check List

Management No. _____

Item	No	Inspection Subject	Requirements	Judgment	Remarks
Visual Check					
Mainframe	1	Enclosure	No scratch, crack, deformation and rust	Pass/Fail	
	2	Labels and panels	No peeling and dust	Pass/Fail	
	3	LCD	No damage	Pass/Fail	
	4	Electrode	No scratch and damage	Pass/Fail	
Accessories	1	Power cord	No scratch and damage	Pass/Fail	
	2	User manual	Kept in proper place	Pass/Fail	
Mechanical Check					
Mainframe	1	Keys	Smooth operation	Pass/Fail	
	2	Recorder	Smooth operation with no abnormal sound	Pass/Fail	
	3	Touch Screen	Smooth operation	Pass/Fail	
Accessories	1	Power cord	Smooth operation and removal	Pass/Fail	
Electrical Check					
Performance	1	Power supply	Screen display upon power-on	Pass/Fail	
	2	Display	No abnormality and flickering	Pass/Fail	
	3	Printing	printing possible	Pass/Fail	
	4	Measurement	Proper measurement	Pass/Fail	
General Judgment				Pass/Fail	
Model		ACCUNIQ BC390		Serial No.	
Installation place			Date of purchase		
Check date		Checked by	Approved by		

Copy this sheet for use
If repair is required, write down so in the Remarks column.

Daily Check List

Management No. _____

Item	No	Inspection Subject	Requirements	Judgment	Remarks
Visual Check					
Mainframe	1	Enclosure	No scratch, crack, deformation and rust	Pass/Fail	
	2	Labels and panels	No peeling and dust	Pass/Fail	
	3	LCD	No damage	Pass/Fail	
	4	Electrode	No scratch and damage	Pass/Fail	
Accessories	1	Power cord	No scratch and damage	Pass/Fail	
	2	User manual	Kept in proper place	Pass/Fail	
Mechanical Check					
Mainframe	1	Touch Screen	Smooth operation	Pass/Fail	
	2	Recorder	Smooth operation with no abnormal sound	Pass/Fail	
Accessories	1	Power cord	Smooth operation and removal	Pass/Fail	
Electrical Check					
Performance	1	Power supply	Screen display upon power-on	Pass/Fail	
	2	Display	No abnormality and flickering	Pass/Fail	
	3	Printing	printing possible	Pass/Fail	
	4	Measurement	Proper measurement	Pass/Fail	
Other	1	Clock	Present date/time	Pass/Fail	
General Judgment				Pass/Fail	
Model		ACCUNIQ BC390		Serial No.	
Installation place			Date of purchase		
Check date		Checked by	Approved by		

Copy this sheet for use
If repair is required, write down so in the Remarks column.



SELVAS Healthcare, Inc.

HEADQUARTERS 155, Sinseong-ro, Yuseong-gu, Daejeon, 34109 Republic of Korea Tel +82 42 879 3000 Fax +82 42 864 4462

When reporting a failure, check the user manual first, and after checking the problem, please inform us the model name, failure status, address, name, phone number, and location, and it would be convenient to know the affiliation and name of the recipient.

※Please understand that it is subject to change without notice to improve the appearance and function of the device.

Service Center	Tel +82 42 879 3000
----------------	---------------------