

# User Manual

[www.accuniq.com](http://www.accuniq.com)



# ACCUNIQ

Adding accuracy to healthcare

User Manual  
BP850



**selvas**   
Healthcare



The device bears the CE label in accordance with the provisions of Medical Device Directive 93/42/EEC.

THE PERSONS RESPONSIBLE FOR PLACING DEVICES ON THE EC MARKET UNDER MDD 93/42/EEC



SELVAS Healthcare, Inc.

155, Sinseong-ro, Yuseong-gu, Daejeon, 34109 Republic of Korea

TEL: 82-42-879-3000, FAX: 82-42-864-4462



Obelis s.a.

Bd. Général Wahis, 53, B-1030, Brussels, Belgium

Any serious incident that has occurred in relation to the device should be reported to the manufacturer and the competent authority of the Member State in which the user and/or patient is established.

# TABLE OF CONTENTS

• INTRODUCTION.....	5
1. INDICATIONS .....	5
2. WORD DEFINITIONS.....	5
3. CLASSIFICATION AND COMPLIANCE.....	6
4. SAFETY PRECAUTIONS.....	6
5. SAFETY SYMBOLS AND INFORMATION.....	9
6. Guidance for Electromagnetic compatibility(EMC).....	12
• TERMS OF EACH PART AND FUNCTIONS.....	16
1. FRONT PART.....	16
2. REAR PART.....	18
3. ACCESSORIES.....	20
4. OPTIONS.....	20
• INSTALLATION.....	21
1. CONNECTING ADAPTER.....	21
2. LOADING THE PRINT PAPER.....	21
3. CONNECTING PORTS.....	23
4. CONNECTING PRINTER.....	23
5. CONNECTING PEDAL SWITCH.....	24
6. CONNECTING HAND SWITCH.....	24
• SYSTEM SETUP.....	25
1. Entering SYSTEM SETUP.....	25
2. Menu.....	25
3. Entering 'MENU' view.....	25
4. How to escape from SYSTEM SETUP.....	25
5. How to move into SYSTEM SETUP.....	25
6. SETUP.....	26
• MEASUREMENT.....	30
1. CAUTIONS FOR MEASUREMENT.....	30
2. MEASUREMENT.....	31
3. RESULT SHEET.....	34
4. The measuring method if ID is on.....	35
5. The measuring method by using 'Three measurement MODE'.....	37
• MAINTENANCE.....	39
• ERROR & REPAIR.....	40
• AFTER SERVICE.....	41

1. AFTER SERVICE.....	41
2. PACKING AND TRANSPORT.....	41
• SPECIFICATION.....	42
• WARRANTY.....	43

## INTRODUCTION

We highly appreciate that you chose our company's product.

You are kindly requested to be familiar with these directions before using this product and always keep it together with the product. In case you are not sure about any directions or problems arising while using the product, please contact our service center.

We will provide you with detailed instructions.

### 1. INDICATIONS

#### Indications for use

The ACCUNIQ BP850 is intended to measure systolic and diastolic blood pressure and pulse rate in adults with an arm circumference of 22-33 cm.

The ACCUNIQ BP850 is intended for use in physicians' offices, hospitals, clinics and other medical facilities where non-invasive blood pressure is performed on patients and invasive measurement is contraindicated.

The blood pressure can be measured using 2 different methods as follow:

1. one measurement with left or right arm
2. two measurements with both arms(BP simultaneous dual-arm measurement)

#### Contraindications for use

As with any non-invasive measurement device, there are clinical conditions which can influence the accuracy of the results. Also, the subject's position, physiological condition and other environmental factors can affect the measurement/calculation.

The ACCUNIQ BP850 Non-Invasive Blood Pressure Monitor should not be used with patients who have the following conditions:

1. Patients with a known arrhythmia.
2. Patients with insufficient peripheral circulation, acute cases of low blood pressure or low temperature.
3. Patients who use a pacemaker.
4. Patients experiencing a seizure.
5. Children younger than 18 years old.
6. Patients who should not have blood pressure measurements taken from their arms.
7. Patients with an artificial heart.
8. Patients whose artery cannot be found by palpation.

### 2. WORD DEFINITIONS

To ensure safe operation and long term performance stability, it is essential that you fully understand the functions, operating and maintenance instructions by reading this manual before operating your unit.

Particular attention must be paid to all warnings, cautions and notes incorporated herein.

The following conventions are used throughout the manual to denote information of special emphasis.

### 3. CLASSIFICATION AND COMPLIANCE

- 1) This device is classified as;
  - Class 1 type-BF against electric shock
  - Ordinary equipment without protection against ingress of water
  - Equipment not suitable for use in presence of a flammable anesthetic mixture by standard of EN 60601-1:2006(Safety of Medical Electrical Equipment)
- 2) This device is complied with Class A for Noise-Emission, Level B for Noise-immunity, by standard of IEC 60601-1-2:2007(Electromagnetic Compatibility Requirements).
- 3) This device is complies with the EN 1060-1: 1995+A2:2009 Non-invasive Sphygmomanometers general requirements as well as EN 1060-3: 1997+A2:2009 supplementary requirements for electro-mechanical blood pressure measuring systems.

### 4. SAFETY PRECAUTIONS

This device is designed and manufactured with consideration of safety of the operator and subject and also to the reliability of the unit.

The following precautions must be observed for additional safety;

This device is designed and manufactured with consideration of safety of the operator and subject and also to the reliability of the unit.

The following precautions must be observed for additional safety;

- ⚠ 1) The unit must be operated only by, or under supervision of a qualified person with our company or our distributors.
- ⚠ 2) This device is specified as Class 1 type BF unit under the standard of EN 60601-1:2006 (Safety of Medical Electrical Equipment).  
Therefore, patients must not touch or handle inner side of the system at any time.
- ⊘ 3) Do not modify the unit. If any modification is needed, ask our company or its authorized dealer for service.
- 4) The unit has previously been adjusted in the factory for optimum performance.
- ⊘ Do not attempt to adjust switches or any other things except those specified in this manual for operation.
- ⚠ 5) If you have experienced any trouble with the unit, switch it off immediately, and contact our company or its authorized dealer for assistance.
- ⚠ 6) If you plan to connect any device of other manufacturers electrically or mechanically to the unit, contact our company or its authorized dealer for instructions before doing so. When you connect computer or other system to the unit (RS-232C), the attached systems should be those certified by IEC 950 or equivalent standards for data processing equipment.  
Configurations shall comply with the system standard EN 60601-1:2006.  
Everybody who connects additional equipment to the signal input part or signal output part configures a medical system standard EN 60601-1:2006.  
If in doubt, consult the A/S department of local distributor.
- ⚠ 7) Avoid the following environments for storage;
  - Where the ambient temperature falls  $-20^{\circ}\text{C}$  or exceeds  $60^{\circ}\text{C}$ .
  - Where the atmospheric pressure falls below 70kPa (700mbar) or exceeds 106kPa (1060mbar).
  - Where the humidity is over 95% non-condensing.
  - Where the unit is exposed to spray or splashing water.

- Where the unit is exposed to dust.
  - Where the unit is exposed to water vapor.
  - Where the unit is exposed to salty atmosphere.
  - Where the unit is exposed to explosive gas.
  - Where the unit is exposed to excessive shocks or vibrations.
  - Where the angle of inclination of mounting surface exceeds 10 degrees.
  - Where the unit is exposed to direct sunlight.
- ⚠ 8) This equipment has been tested and found to comply with the limits for medical devices to the IEC 60601-1-2:2007. These limits are designed to provide reasonable protection against harmful interference in a typical medical installation. This equipment generates uses and can radiate radio frequency energy and, if not installed and used in accordance with the instructions, may cause harmful interference to other devices in the vicinity. However, there is no guarantee that interference will not occur in a particular installation. If this equipment does cause harmful interference to other devices, which can be determined by turning the equipment off and on, the user is encouraged to try to correct the interference by one or more of the following measures:
- Reorient or relocate the receiving device.
  - Increase the separation between the equipment.
  - Connect the equipment into an outlet on a circuit different from that to which the other device(s) are connected.
  - Consult the manufacturer or field service technician for help.
- ⊘ 9) Do not to touch signal input, signal output or other connectors, and the patient simultaneously.
- ⚠ 10) a statement that MEDICAL ELECTRICAL EQUIPMENT needs special precautions regarding EMC and needs to be installed and put into service according to the EMC information provided in the ACCOMPANYING DOCUMENTS;
- ⚠ 11) a statement that portable and mobile RF communications equipment can affect MEDICAL ELECTRICAL EQUIPMENT.
- ⚠ 12) Please consult a physician or a trained health professional for interpretation of measurement results.

### Caution



1. Measurements may be impaired if this device is used near televisions, microwave ovens, X-ray equipment or other devices with strong electrical fields. To prevent such interference, use the meter at a sufficient distance from such devices or turn them off.
2. Incorrect operation or failure of user to maintain the unit spares the manufacturer or his agent of the responsibility for system's non-compliance with specifications or responsibility for any damage or injury.

## Caution



This manual is made for informational purpose and this manual and product are not meant to be a substitute for the advice provided by your own physician or other medical problem. You should not use the information contained in the product for diagnosis or treatment of health problem or prescription of medication by yourself.

If you have or suspect that you have a medical problem, consult with your physician promptly.









Defective unit or accessories must be packed in the replacement cartons to be shipped off from you to our company.







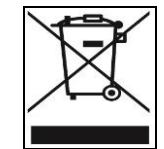
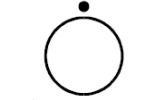
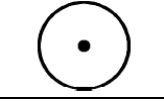



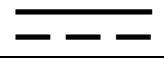

Shipping and insurance costs for return of defective unit must be prepaid by the users.



## 5. SAFETY SYMBOLS AND INFORMATION

The International Electrotechnical Commission (IEC) has established a set of symbols for medical electrical equipment which classifies a connection or warning of any potential hazard. The classifications and symbols are shown below. Save these instructions for your safety.

	<p>Degree of protection against electric shock: TYPE BF</p>
	<p>Please observe operating instructions</p>
	<p>General warning sign</p>
	<p>General prohibition sign</p>
	<p>General mandatory action sign</p>
	<p>Caution</p>
	<p>Waste Electrical and Electronic Equipment (WEEE) The device could be sent back to the manufacturer for recycling or proper disposal after their useful lives. Alternatively the device shall be disposed in accordance with national laws after their useful lives.</p>
	<p>"OFF" (only for a part of equipment)</p>
	<p>"ON" (only for a part of equipment)</p>
	<p>This symbol is used inside system. Identifies the point where the safety ground of the system is fastened to the chassis.</p>

	Do not open. This is for factory only.
	Alternating current
	Direct current
	Date of manufacture
	Manufacturer
	Non-ionizing radiation
	CE mark
	Serial No.
	Authorized representative in the European community.
	Keep dry
	RoHS2
	Foot switch Start or stop the measurement. And, when your arm is oppressed due to high pressurizing or irregular operation is done, press this button then the cuff will be

	exhausted rapidly.
	Hand-held switch Start or stop the measurement. And, when your arm is oppressed due to high pressurizing or irregular operation is done, press this button then the cuff will be exhausted rapidly.

## 6. Guidance for Electromagnetic compatibility (EMC)

Details about the electromagnetic compatibility (EMC) of the ACCUNIQ BP850 are given below. Before using the ACCUNIQ BP850, be sure to read and understand the following information.

### 1) Guidance and manufacturer's declaration – electromagnetic emissions

The ACCUNIQ BP850 is intended for use in the electromagnetic environment specified below. The customer or the user of the ACCUNIQ BP850 should assure that it is used in such an environment.

Emissions test	Compliance	Electromagnetic environment – guidance
RF emissions CISPR 11	Group 1	The ACCUNIQ BP850 uses RF energy only for its internal function. Therefore, its RF emissions are very low and are not likely to cause any interference in nearby electronic equipment.
RF emissions CISPR 11	Class B	The ACCUNIQ BP850 is suitable for use in all establishments, including domestic establishments and those directly connected to the public low-voltage power supply network that supplies buildings used for domestic purposes.
Harmonic emissions IEC 61000-3-2	Class A	
Voltage fluctuations/ flicker emissions IEC 61000-3-3	Compliance	

### 2) Guidance and manufacturer's declaration – electromagnetic immunity

The ACCUNIQ BP850 is intended for use in the electromagnetic environment specified below. The customer or the user of the ACCUNIQ BP850 should assure that it is used in such an environment.

Immunity test	IEC 60601 test level	Compliance level	Electromagnetic environment-guidance
Electrostatic discharge(ESD) IEC 61000-4-2	±6kV: Contact ±8kV: Air	±6kV: Contact ±8kV: Air	Floors should be wood, concrete or ceramic tile. If floors are covered with synthetic material, the relative humidity should be at least 30 %.
Electrical fast transition/burst IEC 61000-4-4	±2kV: Power supply lines ±1kV: Input/output lines	±2kV: Power supply lines ±1kV: Input/output lines	Mains power quality should be that of a typical commercial or hospital environment.
Surge IEC 61000-4-5	±1 kV differential mode ±2 kV common mode	±1 kV differential mode ±2 kV common	Mains power quality should be that of a typical commercial or hospital environment.

		mode	
Voltage drops, dips, and fluctuations of input power supply line IEC 61000-4-11	<5 % <i>UT</i> (>95 % dip in <i>UT</i> ) for 0,5 cycle 40 % <i>UT</i> (60 % dip in <i>UT</i> ) for 5 cycles 70 % <i>UT</i> (30 % dip in <i>UT</i> ) for 25 cycles <5 % <i>UT</i> (>95 % dip in <i>UT</i> ) for 5 sec	<5 % <i>UT</i> (>95 % dip in <i>UT</i> ) for 0,5 cycle 40 % <i>UT</i> (60 % dip in <i>UT</i> ) for 5 cycles 70 % <i>UT</i> (30 % dip in <i>UT</i> ) for 25 cycles <5 % <i>UT</i> (>95 % dip in <i>UT</i> ) for 5 sec	Mains power quality should be that of a typical commercial or hospital environment. If the user of the ACCUNIQ BP850 requires continued operation during power mains interruptions, it is recommended that the ACCUNIQ BP850 be powered from an uninterruptible power supply or a battery.
Magnetic field of commercial frequency (50/60Hz) IEC 61000-4-8	3 A/m	3 A/m	Power frequency magnetic fields should be at levels characteristic of a typical location in a typical commercial or hospital environment.

<b>Note</b>	
	<i>UT</i> is the a.c. mains voltage prior to application of the test level.

### 3) Guidance and manufacturer's declaration – electromagnetic immunity 2

The ACCUNIQ BP850 is intended for use in the electromagnetic environment specified below. The customer or the user of the ACCUNIQ BP850 should assure that it is used in such an environment.

Immunity test	IEC 60601 test level	Compliance level	Electromagnetic environment-guidance
Conducted RF IEC 61000-4-6	3 Vrms 150 kHz to 80 MHz	3 Vrms	Portable and mobile RF communications equipment should be used no closer to any part of the ACCUNIQ BP850, including cables, than the recommended separation distance calculated from the equation applicable to the frequency of the transmitter.  <b>Recommended separation distance</b>  $d = 1.2\sqrt{P}$
Radiated RF IEC 61000-4-3	3 V/m 80 MHz to 2,5 GHz	3 V/m	

		<p><math>d = 1.2\sqrt{P}</math> 80 MHz to 900 MHz</p> <p><math>d = 2.3\sqrt{P}</math> 900 MHz to 2,5 GHz</p> <p>where <math>P</math> is the maximum output power rating of the transmitter in watts (W) according to the transmitter manufacturer and <math>d</math> is the recommended separation distance in meters (m).</p> <p>Field strengths from fixed RF transmitters, as determined by an electromagnetic site survey,<sup>a</sup> should be less than the compliance level in each frequency range.<sup>b</sup></p> <p>Interference may occur in the vicinity of equipment marked with the following symbol:</p> 
--	--	---

<p><b>Caution</b></p> 	<p>1. At 80 MHz and 900 MHz, the higher frequency range applies.</p> <p>2. These guidelines may not apply in all situations. Electromagnetic propagation is affected by absorption and reflection from structures, objects and people.</p> <p><sup>a</sup> Field strengths from fixed transmitters, such as base stations for radio (cellular/cordless) telephones and land mobile radios, amateur radio, AM and FM radio broadcast and TV broadcast cannot be predicted theoretically with accuracy. To assess the electromagnetic environment due to fixed RF transmitters, an electromagnetic site survey should be considered. If the measured field strength in the location in which the ACCUNIQ BP850 is used exceeds the applicable RF compliance level above, the ACCUNIQ BP850 should be observed to verify normal operation. If abnormal performance is observed, additional measures may be necessary, such as reorienting or relocating the ACCUNIQ BP850.</p> <p><sup>b</sup> Over the frequency range 150 kHz to 80 MHz, field strengths should be less than 3 V/m.</p>
---	--

**4) Recommended separation distances between portable and mobile RF communications equipment and the ACCUNIQ BP850**

The ACCUNIQ BP850 is intended for use in an electromagnetic environment in which radiated RF disturbances are controlled. The customer or the user of the ACCUNIQ BP850 can help prevent electromagnetic interference by maintaining a minimum distance between portable and mobile RF communications equipment (transmitters) and the ACCUNIQ BP850 as recommended below, according to the maximum output power of the communications equipment.

Rated maximum output power of transmitter W	Separation distance according to frequency of transmitter m		
	150 kHz to 80 MHz $d=1.2\sqrt{P}$	80 MHz to 900 MHz $d=1.2\sqrt{P}$	900 MHz to 2,5 GHz $d=1.2\sqrt{P}$
0.01	0.12	0.12	0.23
0.1	0.38	0.38	0.73
1	1.2	1.2	2.3
10	3.8	3.8	7.3
100	12	12	23

For transmitters rated at a maximum output power not listed above, the recommended separation distance  $d$  in meters (m) can be estimated using the equation applicable to the frequency of the transmitter, where  $P$  is the maximum output power rating of the transmitter in watts (W) according to the transmitter manufacturer.

**Caution**



1. At 80 MHz and 900 MHz, the separation distance for the higher frequency range applies.
2. These guidelines may not apply in all situations. Electromagnetic propagation is affected by absorption and reflection from structures, objects and people.

## TERMS OF EACH PART AND FUNCTIONS

### 1. FRONT PART

① START / STOP BUTTON

Press 'Start' to start the measurement. The cuff starts winding up automatically and begins to pressurize. Press the button to stop the measurement. Pressurization will stop and the air will be exhausted from the cuff.

② LCD DISPLAY

The measurement process is displayed in letters and animations. After the test, the result is displayed; Systolic/ Diastolic blood pressure, Pulse, Pulse wave pattern, Blood pressure.

③ CLOCK SECTION (Date and Time)

On the right upper corner of LCD screen, date and time are displayed.

④ PRINTER COVER

It protects the printer.

⑤ Printer outlet of the result sheet

Result sheet is automatically printed out. Automatic cutter is equipped inside and it cuts the result sheet automatically.

⑥ CUFF

It automatically wraps and releases the arm for measurement.

⑦ ARM REST

When the arm is placed on the cuff, it sustains the arm and makes the right position.

⑧ ARM SENSOR

You can choose measuring site among three (left arm, right arm or both arms) based on recognition of the arms through the arm sensor.

⑨ EMERGENCY STOP BUTTON

When a user feels the pain due to high pressurization or irregular operation, press the button to stop the operation. The air will be rapidly exhausted from the cuff.

⑩ HAND SWITCH REST

When the cable switch is used, switch rest can be placed in the right side of device.

⑪ HAND SWITCH

When the user measures blood pressure on both arms, push the hand switch to START and STOP the device.

⑫ PEDAL SWITCH

It is placed under the cart. It works as 'START/STOP'.



FRONT PART

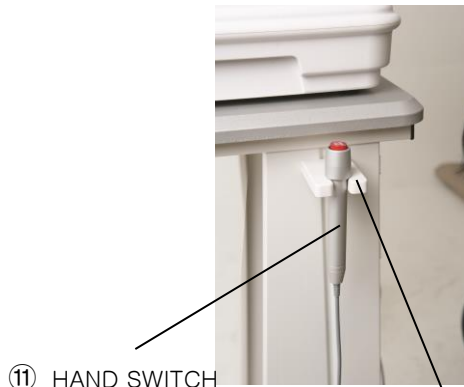
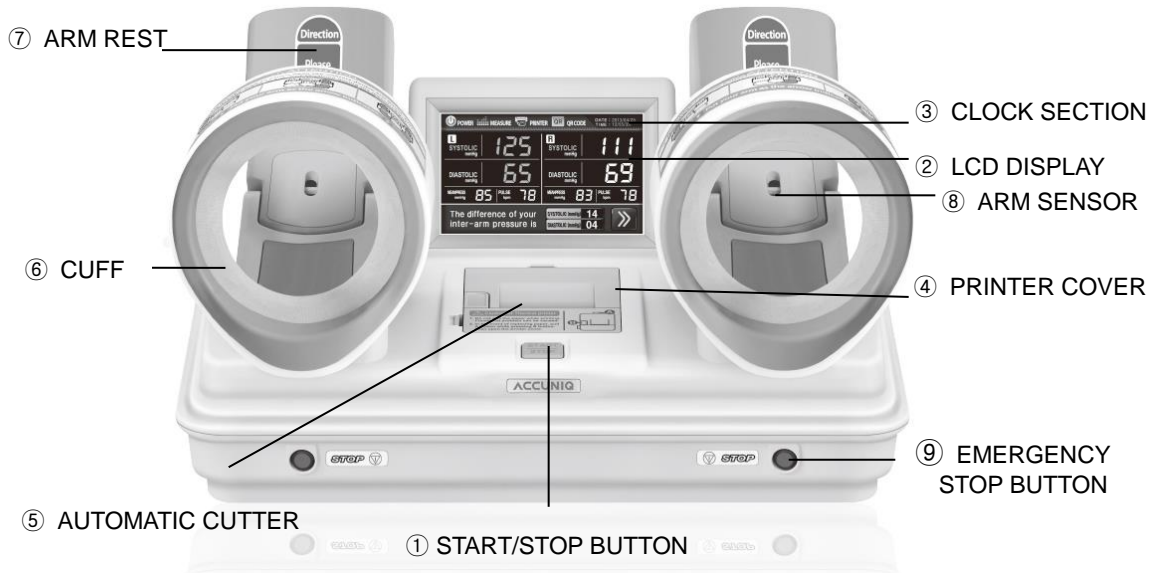

The side part of cart



The under part of cart

## 2. REAR PART

- ① POWER  
It turns the power on and off.
- ② POWER INPUT  
It connects the adapter.
- ③ R-CAL  
It is only for the inspection. Do not open it.
- ④ L-CAL  
It is only for the inspection. Do not open it.
- ⑤ EARTH (POTENTIAL EQUALIZATION TERMINAL)  
For safety, the device should be placed on the flat surface.
- ⑥ COMMUNICATION PORTS (RS-232C)  
It connects the main to other equipments with cable (RS-232C) to transfer the data.
- ⑦ USB PORT (A TYPE)  
It connects the main body with USB cable (A type).
- ⑧ USB PORT (B TYPE)  
It connects the main body with USB cable (B type).
- ⑨ PEDAL BUTTON PORT  
It connects the PEDAL switch.
- ⑩ HAND BUTTON PORT  
It connects the HAND switch.
- ⑪ INFORMATION BOARD FIXER  
It fixes the Information Board.

## REAR PART

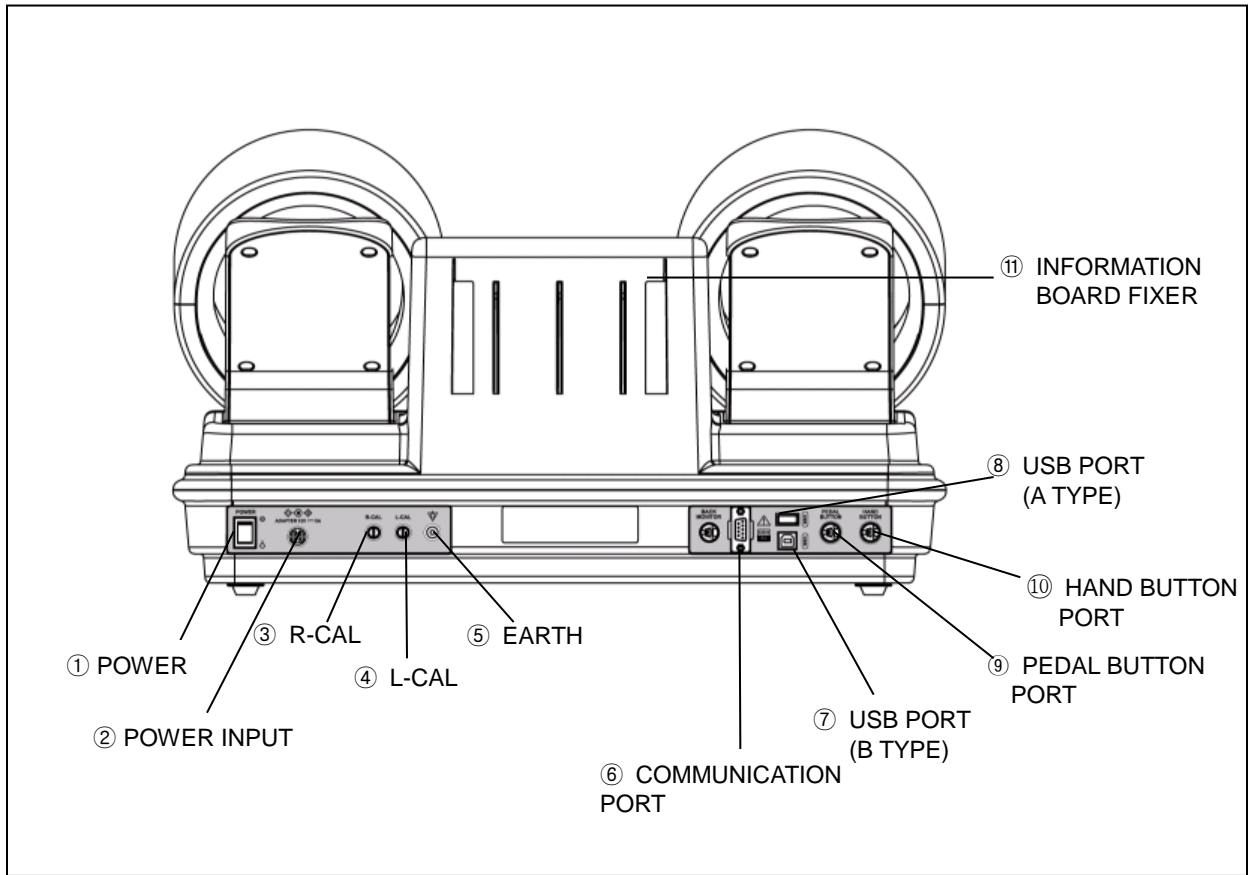

### Note



The operator should not touch both USB port and the patient's body simultaneously.

### 3. ACCESSORIES

Adapter/Power cable

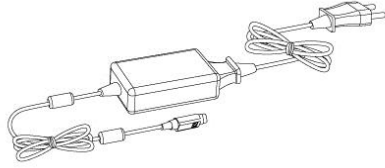

User guide



PEDAL /HAND SWITCH

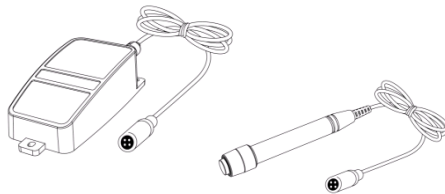

GUIDE

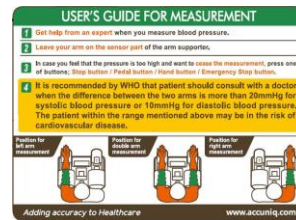

Thermal paper / ROLLER



Cart



### 4. OPTIONS

Chair



A4 RESULT SHEET



## INSTALLATION

### 1. CONNECTING ADAPTER

Connect the adaptor to the power input on the back of the device.  
Turn on the POWER switch.

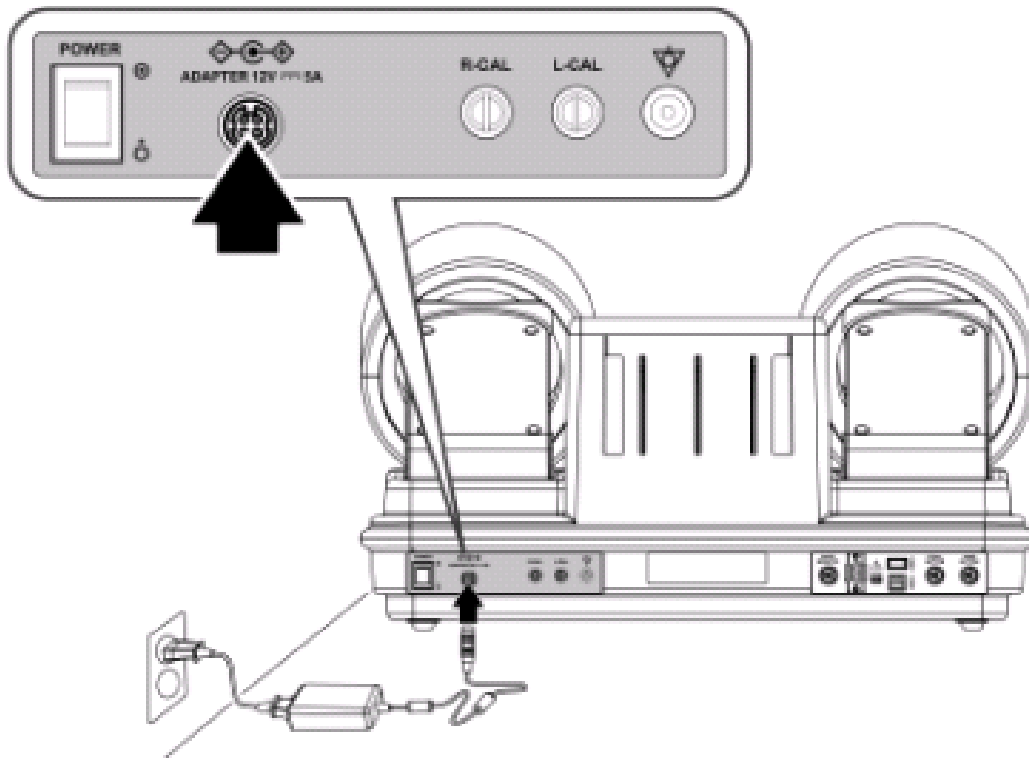

#### Caution



In order to avoid the risk of electrical shock, connect this device only to the power supply equipped with the protective grounding.

#### Caution



When connecting adaptor, place the arrow mark of adaptor connection part up and correctly stick it in the socket on the rear of the main body.  
Wrong connection could be a fire hazard.

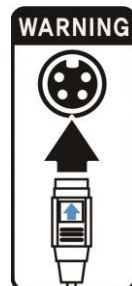

## 2. LOADING THE PRINT PAPER

- ① Pull the Top button up. Then press the Side button. Open the upper printer cover.
- ② Put the roller into the center hole of the thermal paper.
- ③ Insert the thermal paper with the roller into the holder as shown in the picture.
- ④ Take the edge of the paper out.
- ⑤ Close the cover.
- ⑥ It automatically cuts the paper.

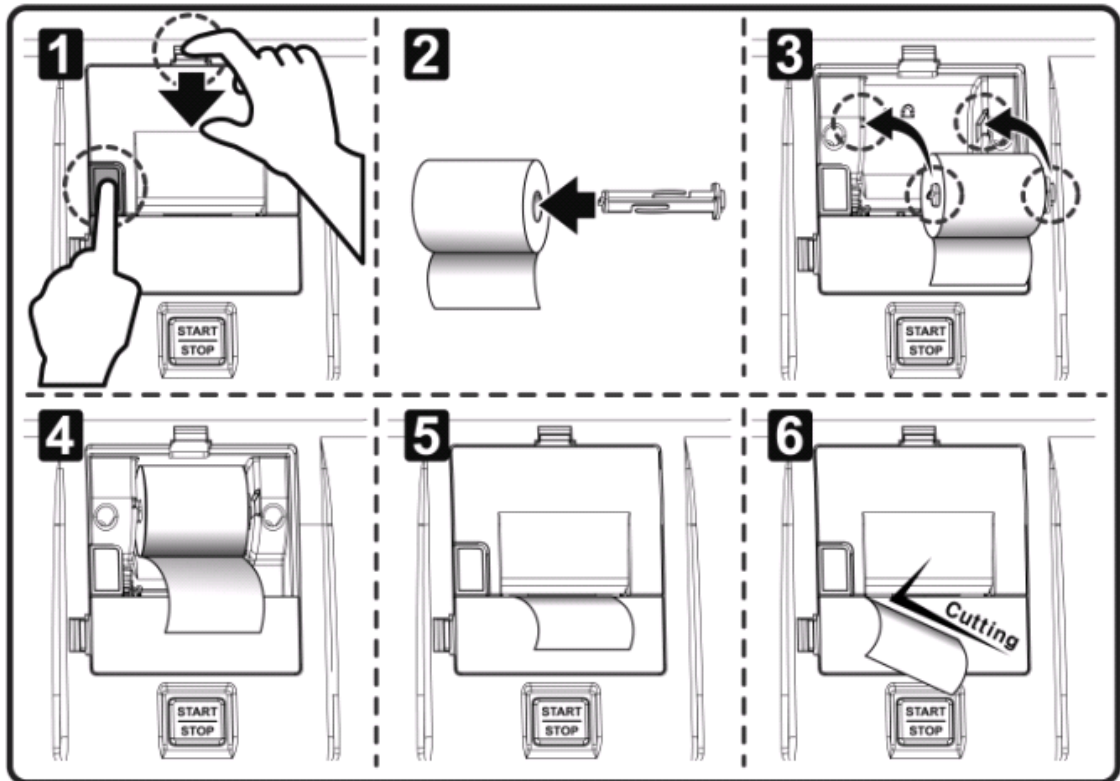

### Note



Thermal paper doesn't need the ink.  
One side is smooth and another is rough. It prints the letter only on the smooth side.  
Always check the remainder of the paper and replace it at any time.  
When the red line appears on the right corner of the paper, replace the paper.  
Use only the exclusive paper (57mm).  
Keep paper rolls in a dark and ventilated place.  
Avoid the dust on the paper.  
Do not pull the paper during printing. It may cause a jam.  
When the paper is not loaded correctly, the paper will not be printed out properly and it may cause the breakdown.  
When the printer cover is not properly closed, the paper can be jammed inside. When the problem occurs, check the printer cover.

### 3. CONNECTING COMMUNICATION PORT

To transmit the data, connect ACCUNIQ BP850 to a computer or other external devices. Insert USB cable to the communication port and connect it to the computer as shown in the picture below.

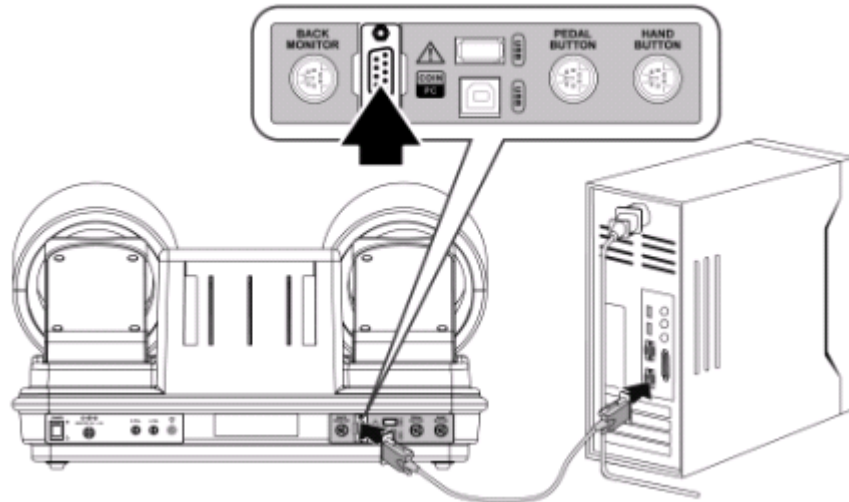

### 4. CONNECTING PRINTER (Option)

Connect A4 printer for the output in A4 size. Insert USB cable to the communication port and connect it to the printer as shown in the picture below.

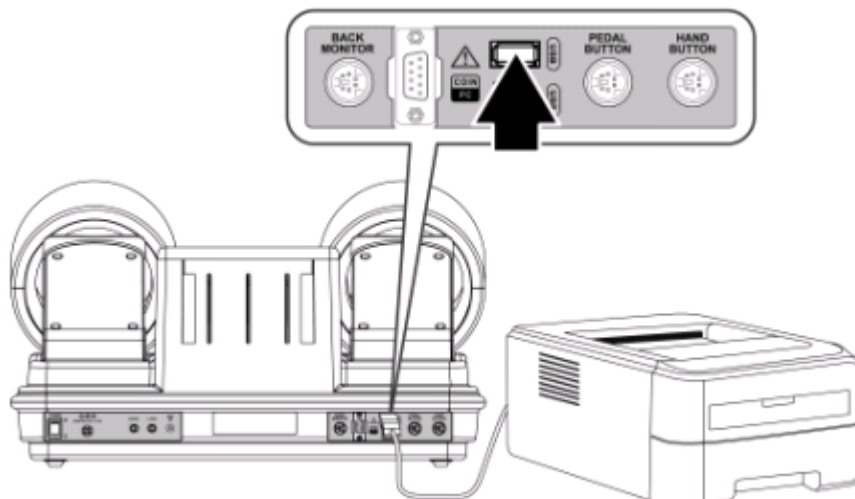

## 5. CONNECTING PEDAL SWITCH

Connect the PEDAL SWITCH as shown in the picture.

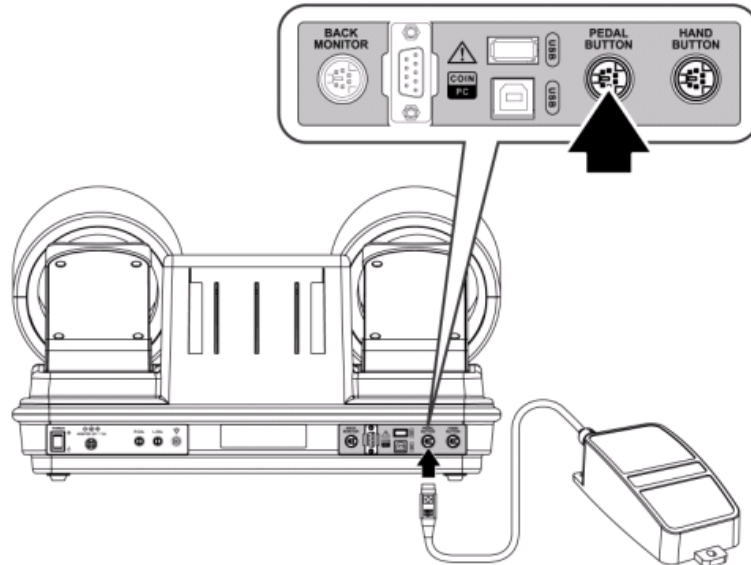

## 6. CONNECTING HAND SWITCH

Connect the PEDAL SWITCH as shown in the picture.

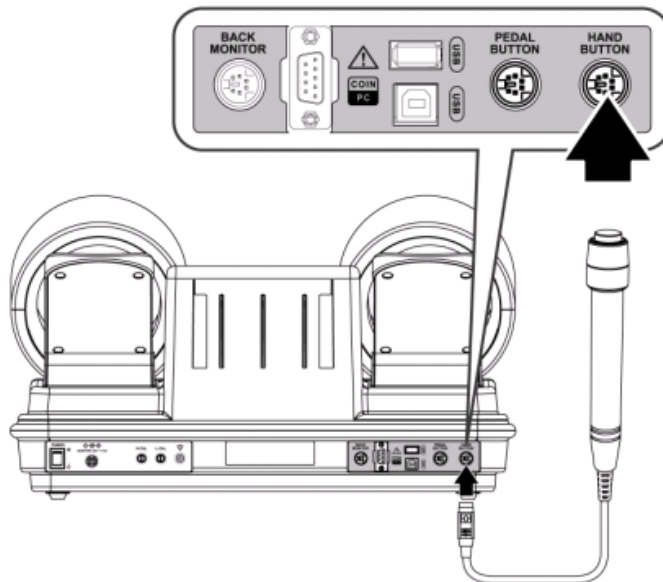



# SYSTEM SETUP

Set the operating conditions for ACCUNIQ BP850.

## 1. Entering SYSTEM SETUP

At the initial screen, press 'Power' button on the left upper corner for 4~5seconds. Popup screen appears as shown in the picture. Press '1->2->3->4' to enter SYSTEM SETUP.



## 2. Menu

1. DATE TYPE
2. DATE/TIME
3. VOLUME
4. PRINT
5. MEASUREMENT MODE
6. Automatic return to initialized screen
7. LOGO
8. PERSONAL DATA INPUT
9. VOICE

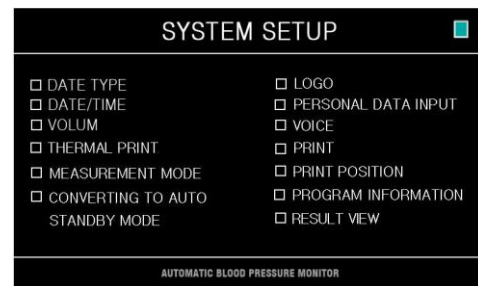

## 3. Entering 'MENU' view

Select the menu on the touch screen.

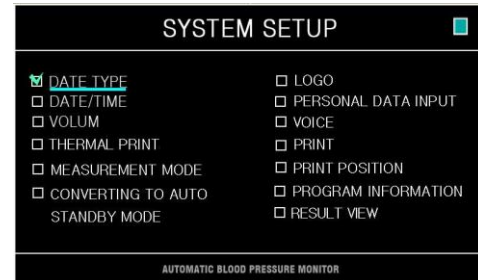

## 4. How to escape from SYSTEM SETUP

Press the blue icon on the upper right corner. The initial screen appears.

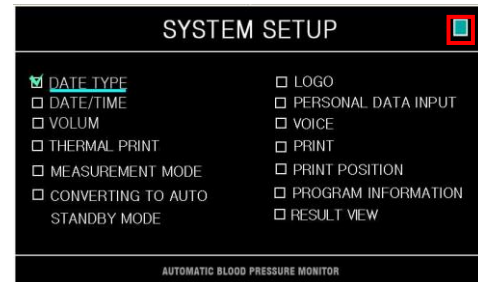

## 5. How to move into SYSTEM SETUP

After setting the system from the selected menu, press the blue icon on the upper right corner. The initial screen appears.

## 6. Setup

### <DATE TYPE>

Set the Date Format.

- Pre-set: YY-MM-DD (Year-Month-Day)
- Select 'Date type'.
- Press 'SET' to save the change.
- Press 'CLOSE' and get back to SYSTEM SETUP menu.

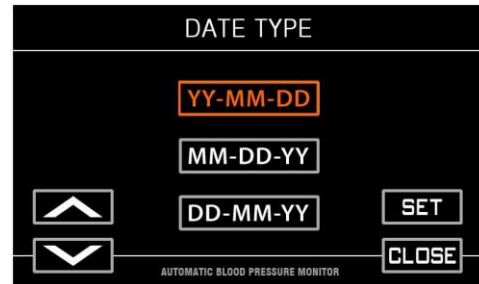

### < DATE/TIME >

Set the current time and the date.

- Pre-set: The date released from the factory.
- Select Date/Time and enter the menu.
- Press 'YEAR' and the color changes.
- Press '^' button to increase the number.
- Press 'v' button to decrease the number.
- After setting the current year, move to Month.
- Set the current month by pressing '^' and 'v' button.
- Set the date, hour, and minute by following the instructions mentioned above.
- Save the change with 'SET' button.
- Press 'CLOSE' to get back to SYSTEM SETUP menu.

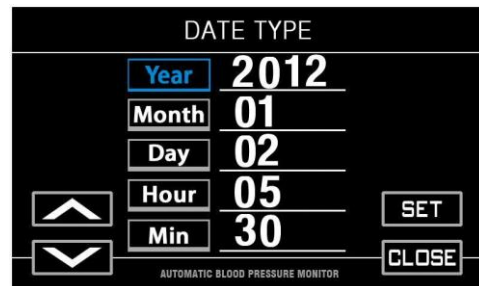

### Note



Press 'CLOSE' to stop setting the date and time.

For Date/Time, all settings should be done at once; hour, minute, month, day and year.

If you press 'CLOSE' and stop the setting, the time and date returns to the old setting.

The function of Time and Calendar keeps running even after the power is off.

Calendar program is set for 100 years, and it adjusts automatically even at a leap year.

### < VOLUME >

Set the volume of key sound on the top monitor.

- Pre-set: 2
- Select 'VOLUME' and enter the menu.
- Set the volume by pressing '^', 'v' button.
- Press 'SET' to save the change.
- Press 'CLOSE' to get back to SYSTEM SETUP menu.

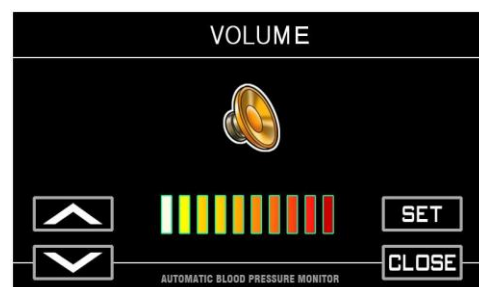

### <THERMAL PRINT>

Choose the print option and set the result sheet form.

- Pre-set: ON
- Select 'THERMAL PRINT' and enter the menu.
- ON: Result sheet is printed after the measurement.
- OFF: Result sheet is not printed after the measurement.
- Press 'RESULT SHEET FORM' and enter the menu.
- Select the print form and press 'SET' button.
- Press 'CLOSE' to get back to 'THERMAL PRINT' menu.
- Press 'CLOSE' to get back to SYSTEM SETUP menu.

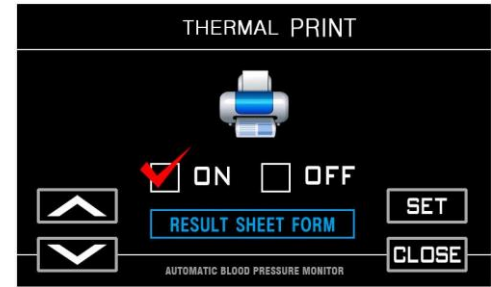

### < MEASUREMENT MODE>

Select the measurement mode.

\*Simple Measurement mode: Measure blood pressure on both arms simultaneously at once.

\*Three Measurement mode: Measure blood pressure on both arms 3 times in a row. The average blood pressure is displayed as a result.

- Pre-set: Simple measurement mode
- Select the 'MEASUREMENT MODE' and enter the menu.
- Select either 'SIMPLE MEASUREMENT MODE' or 'Three Measurement MODE'.
- Set the interval time when 'Three Measurement MODE' is selected. The interval time is the break time between three times of measurements. Select the time from 15sec, 30sec, 45sec and 60sec. Press 'SET' to save the change.
- Press 'CLOSE' to get back to SYSTEM SETUP menu.

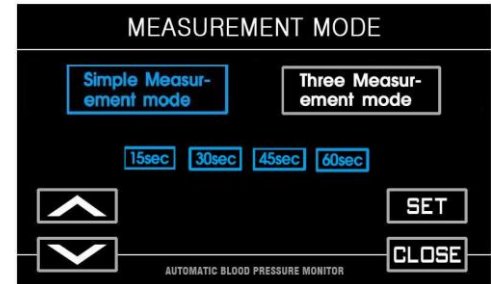

### < CONVERTING TO AUTO STANDBY MODE >

After the measurement, the result screen automatically returns to the initial screen.

- Pre-set: ON
- Select the 'Converting to auto standby mode' and enter the menu.
- Select either 'ON' or 'OFF'.
- Press 'SET' to save the change.
- Press 'CLOSE' to get back to SYSTEM SETUP menu.

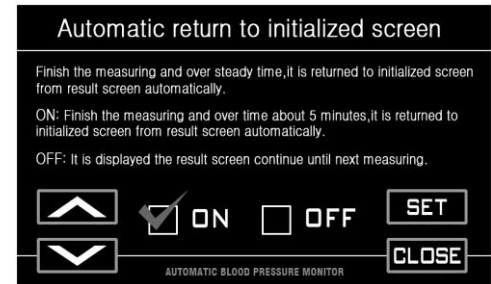

### < LOGO >

Set 'LOGO' position.

- Select 'LOGO' and enter the menu.
- Select either 'THE UPPER LOGO' or 'THE UNDER LOGO'.
- If the user wants to delete LOGO press 'DELETE'.
- Press 'SET' to save the change.
- Press 'CLOSE' to get back to SYSTEM SETUP menu.

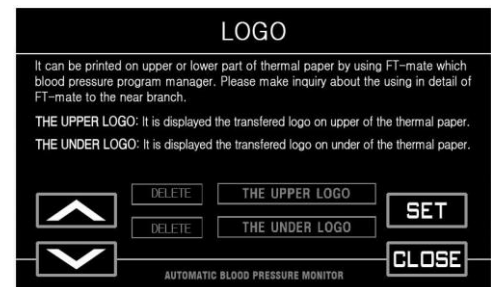

### < PERSONAL DATA INPUT >

It allows the user to input personal data.

- Select 'PERSONAL DATA INPUT' and enter the menu.
- Select either 'ON' or 'OFF' for ID.
- Select either 'ON' or 'OFF' for HEIGHT/WEIGHT INPUT.
- Press 'SET' to save the change.
- Press 'CLOSE' to get back to SYSTEM SETUP menu.



### < VOICE >

It sets the voice guidance.

- Pre-set: ON
- Select 'Voice' and enter the menu.
- Select either 'ON' or 'OFF'.
- Press 'SET' to save the change.
- Press 'CLOSE' to get back to SYSTEM SETUP menu.

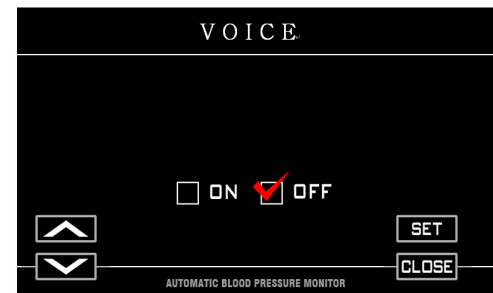

### < PRINT >

It selects the printing mode of the A4 printer.

(The printer and pre-formatted result sheet is optional.)

- Select 'PRINT' and enter the menu.
- Pre-set: AUTO
- AUTO: It is printed automatically.
- Manual: It is printed manually.
- Off: It is not printed.
- Press 'SET' button on touch pad to save it.
- Press 'CLOSE' to get back to SYSTEM SETUP menu.

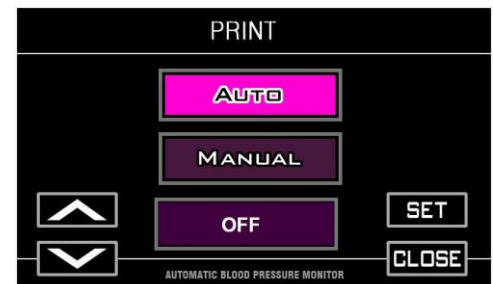

### < PRINT POSITION >

It adjusts the printing position in the direction of U-D (up-down) and L-R (left-right) to fit to the pre-formatted result sheet.

- Select 'PRINT POSITION' and enter the menu.
- Pre-set: 00 for U-D and 00 for L-R
- Range: 99 for U-D and 99 for L-R
- Choose U-D by pressing '▼, ▲' on touch pad. Choose L-R by pressing '►, ◀' on touch pad.

- Pressing ► button moves print position down or right.
- Pressing ◀ button moves print position up or left.
- Every single press moves print position by about 0.2 mm.
- Press 'SET' button on touch pad to save it.
- Press 'CLOSE' to get back to SYSTEM SETUP menu.

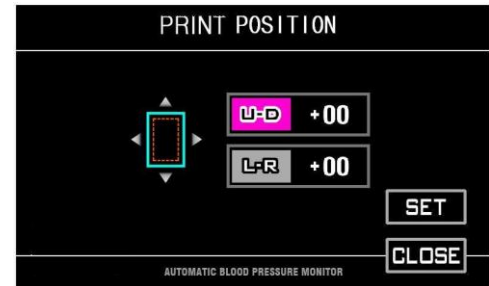

### Note



L-R (left-right): - is moving to the left and + is moving to the right.  
U-D (up-down): - is moving up and + is moving down.

### <PROGRAM INFORMATION >

It is for check the program information of this device.

- Select 'PROGRAM INFORMATION' and enter the menu.
- Check the version and information of this program.
- Press 'CLOSE' to get back to SYSTEM SETUP menu.

### <RESULT VIEW>

It sets the result screen type.

- Pre-set : GENERAL TYPE
- Select 'RESULT VIEW' and enter the menu.
- Select the result type.
- \* GENERAL TYPE: Basal type.
- \* DIAGRAM TYPE: The Blood pressure displayed by gage.
- Press 'SET' button on touch pad to save it.
- Press 'CLOSE' to get back to SYSTEM SETUP menu.

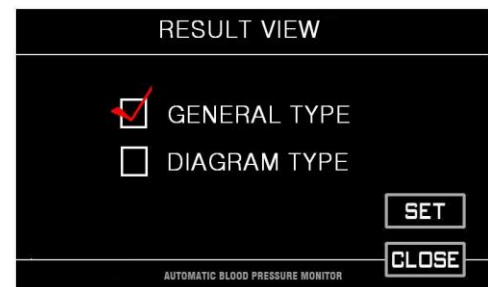

## MEASUREMENT

### 1. CAUTIONS FOR MEASUREMENT

- ① Take off heavy sweater or shirts.
- ② Have a rest before the measurement.
- ③ Do not move or talk during the measurement.
- ④ Do not measure in following positions; standing, half-sitting, leg-crossed.
- ⑤ Put your arm properly into the arm support.
- ⑥ When you roll up the sleeves, make sure that the rolled up sleeves are not pressing the upper arms.
- ⑦ When the pulse is running too weak and hard to be heard from stethoscope, ACCUNIQ BP850 can not make a measurement.
- ⑧ During the measurement, straighten your back and relax your arm.

#### Caution



This device is only for adult.

## 2. MEASUREMENT

\*There are 3 ways to measure blood pressure.

### 1) Measuring method by using a foot switch.

(Measure blood pressure on both arms simultaneously.)

- ① Plug the cable and turn on the power.

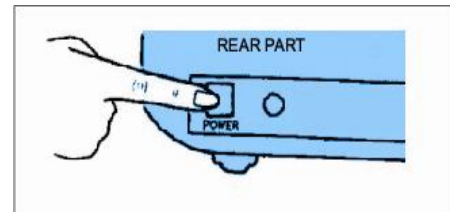

- ② As the power is on, the message appears as shown in the picture.

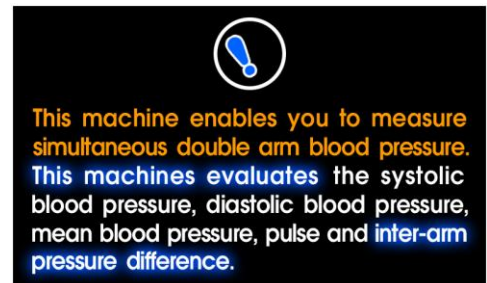

- ③ Put both arms into the cuff.
- ④ There's Pedal Switch placed at the bottom of the cart. Step down the pedal to start the measurement.

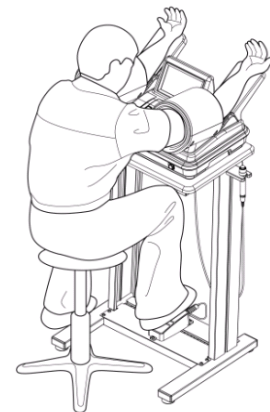

### Caution



Place your arm on the arm supporter with the palm facing up. Adjust the height of the chair so that the arm stays on the same height of the heart. When the arm is placed lower than the heart, blood pressure will be higher than actual value, and vice versa.

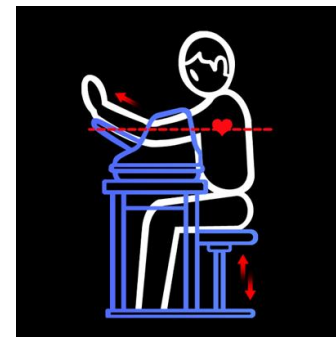

- ⑤ Pressurization starts automatically from the cuff and LCD indicates the current status.



- ⑥ When the measurement is completed, LCD screen displays the results. At the same time, voice guidance speaks out, "Measurement completed, pull your arm out please. Thank you." The cuff deflates and turns to the initial state.



**Note**

When the difference between the two arms is more than 20mmHg for systolic blood pressure or 10mmHg for diastolic blood pressure, the difference is indicated in red.

- ⑦ The result is printed out automatically.

**Note**

At the system setup, there's PRINT ON/OFF. If the print is off, the result sheet is not printed out.

- ⑧ Pull your arm out from the cuff.

- ⑨ When you press button on the result screen, it indicates which category your blood pressure is classified into. Gray represents the blood pressure of your left arm.

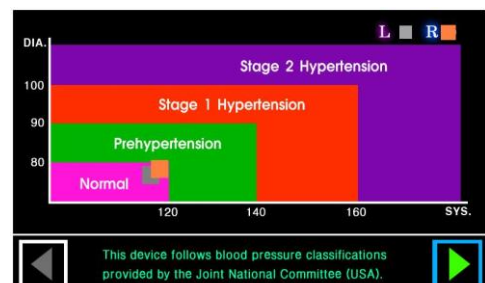



- ⑩ When you want to measure one more time, press  button.  
The whole procedure restarts again.

## 2) Measuring method by using a hand switch.

(Measure blood pressure on both arms simultaneously.)

- ① Plug the cable and turn on the power.
- ② As the power is on, LCD displays the Standby mode.
- ③ Put both arms into the cuff.
- ④ An assistant stands next to the measurer and press 'START'.  
Pressurization starts automatically from the cuff and LCD indicates the current status.



The next step is same as the instruction ⑤, ⑥, ⑦, ⑧, ⑨, ⑩ from  
'1) Measuring method by using a foot switch'.

## 3) Measuring method by one arm.

(Measure blood pressure on one arm.)

- ① Plug the cable and turn on the power.
- ② As the power is on, LCD displays the Standby mode.
- ③ Put right or left arm to the cuff.



### Note



For measuring right arm, put right arm into the cuff on the right side.  
For measuring left arm, put left arm into the cuff on the left side.

- ④ Press the start  
Pressurization starts automatically from the cuff and LCD indicates the current status.

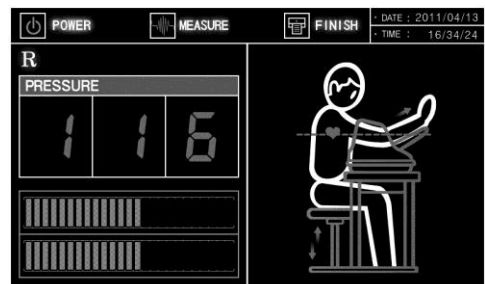

- ⑤ When the measurement is completed, LCD screen displays the results.  
 At the same time, voice guidance speaks out, "Measurement completed, pull your arm out please. Thank you."  
 The cuff deflates and turns to the initial state.



### 3. Result sheet

#### ▼ Result sheet format (both arms)

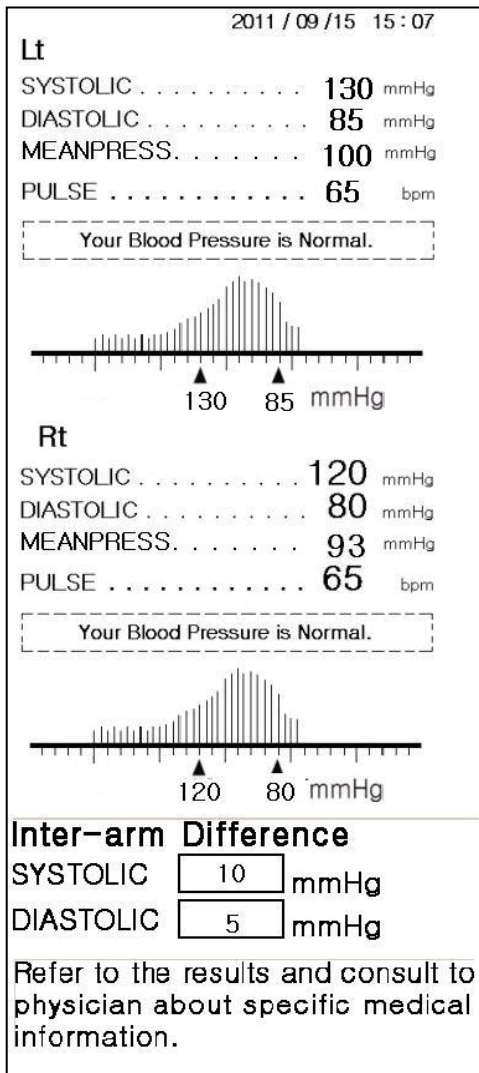

#### ▼ Result sheet format (one arm)

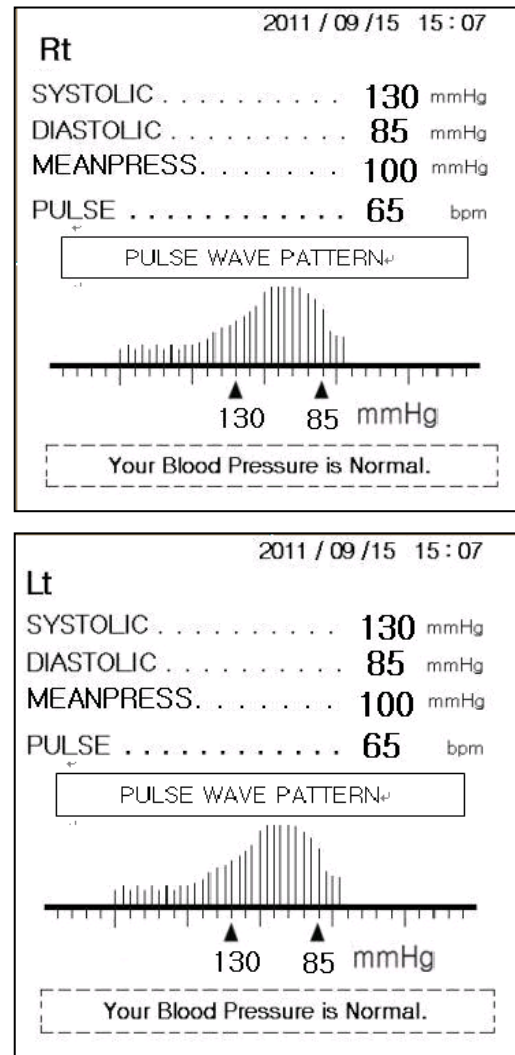

▼ Classification of the blood pressure

: National High Blood Pressure Education Program, National Heart, Lung and Blood institute, NIH (JNC7, 2003)

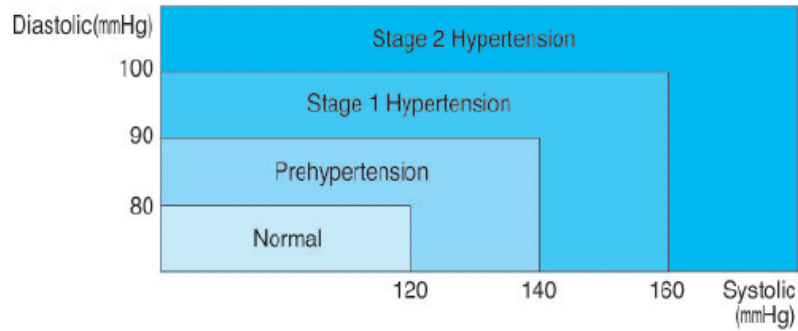

**4. Measuring method with ID**

Enter SYSTEM SETUP. From 'PERSONAL DATA INPUT', activate ID use.

① Input data

ID: On the initial display, press 'ID'.

Enter ID using the number buttons.

- ID Input Range is from 000000001 to 999999999.

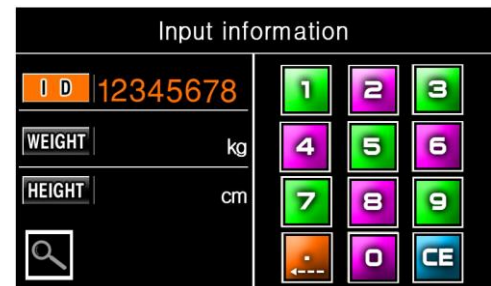

Weight: After entering ID, press 'WEIGHT'.

Enter weight.

- Weight Input Range is 10.0~248.0kg.

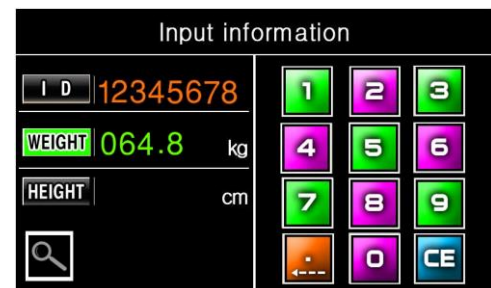

Height: After entering weight, press 'HEIGHT'.

Enter height.

- Height Input Range is 80.0~238.0cm.

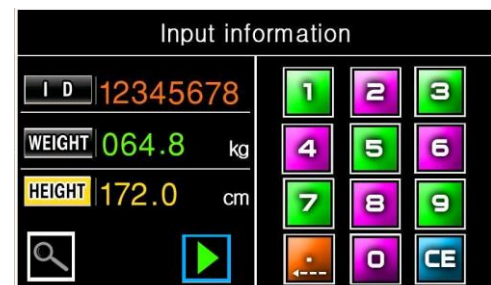

② Measurement

After entering the personal data, press 'START'.  
Pressurization starts automatically from the cuff and LCD indicates the current status.

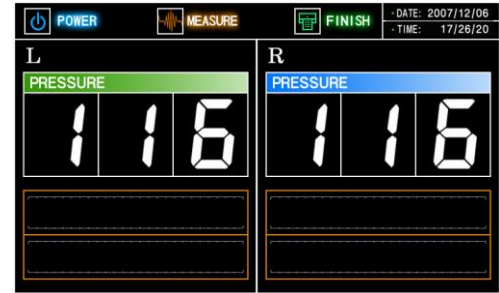

③ Result

When the measurement is completed, the user's ID, weight, height, Body Mass Index (B.M.I) and fatness are displayed as shown in the picture.



④ Criterion for judging result

- Body Mass Index (B.M.I.): It is a health indicator; kg/ m<sup>2</sup>

\*EAST ASIA

section	thin	normal	overweight	obese
	<18.5kg/m <sup>2</sup>	18.5~<23.0kg/m <sup>2</sup>	23.0~<25.0kg/m <sup>2</sup>	25.0kg/m <sup>2</sup> and over

\* EU and etc.

section	thin	normal	overweight	obese
	<18.5kg/m <sup>2</sup>	18.5~<25.0kg/m <sup>2</sup>	25.0~<30.0kg/m <sup>2</sup>	30.0kg/m <sup>2</sup> and over

- Fatness: Based on the standard weight, it calculates how fat the user is in percentage.

$$\left[ \frac{\text{current weight} - \text{standard weight}}{\text{standard weight}} \times 100 \right] + 100$$

$$\text{standard weight} = \text{height(m)}^2 \times 22$$

section	Very thin	thin	normal	overweight	obese
	<80%	80%~90%	90%~110%	110%~120%	>120%

## 5. The measuring method by 'THREE MEASUREMENT MODE'.

It measures blood pressure 3 times in a row. The average blood pressure from the three measurements indicates the more accurate data.

It is possible to measure either one arm or both arms.

System setup -> Measurement Mode -> Three measurement mode

You can set the measuring interval. (15sec, 30sec, 45sec, 60sec)

### ① Measurement

Put both arms or one arm to the cuff and press 'START' button.

Pressurization starts automatically from the cuff and LCD indicates the current status.



When the first measurement is completed, device stops until the interval time the user sets.

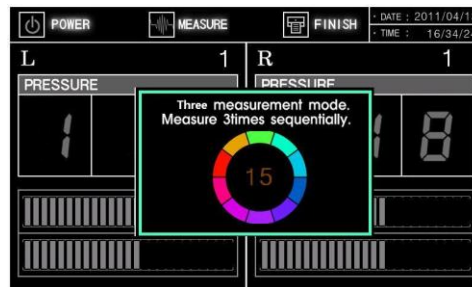

When the second measurement is completed, device stops until the interval time the user sets.

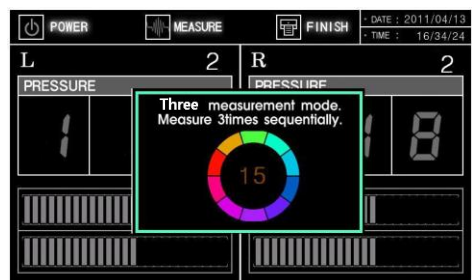

It performs the measurements three times in a row.

② Result

After the third measurements, the average blood pressure is indicates as follows.



## MAINTENANCE

- 1) Pay attention to allowable current value of power.
- 2) Avoid direct sunlight, humidity, dust, thick oil and salty or extreme changes in temperature.
- ⊘ 3) Do not install or store this device in some space where any chemicals or gas is stored.
- ⊘ 4) Do not use this device in any unstable, vibrating, or impact-giving area.
- 5) Connect the earth placed on the backside of this device to terminal plate to prevent any electric shock from leakage current or a potential difference.
- ⊘ 6) Do not put or drop anything on this device and avoid strong impact.
- ⊘ 7) Do not disassemble or remodel this device.
- 8) If this unit has not been used for a long time, use this after confirming by an expert if all function and appearance are in good condition.
- ⊘ 9) Do not splash any fluid on this device or insert any foreign substances.
- 10) In case of inserting foreign substances or exposing to particular environment, this device must be examined by an expert before use.
- 11) Use the power cable, plug, and fuse that are offered by our company.  
At this time, confirm the covering of cable, the state of plug connection, and other check points to the things below.
  - RS 232C cable
  - USB port
  - Adapter
- 12) When pulling out the power cable, turn off the power switch first and then pull the plug out.
- 13) Storage ambient: Temperature -10 ~ 60 °C, Humidity lower than 95 % (non condensing)
- 14) Operation ambient: Temperature 10 ~ 40 °C, Humidity 30 ~ 75 % (non condensing)
- ⊘ 15) Do not store or use this device under 70 kPa (700 mbar) or over 106 kPa (1060 mbar) of atmospheric pressure.
- 16) Cleaning & Disinfection
  - ① Cleaning: When cleaning, use a soft cloth but do not use volatile solvent like benzene and alcohol or a wet cloth. Wipe out minute dust once per 2 ~ 3 days with a dry cloth.
  - ② Disinfection: Spray alcoholic water of glutaraldehyde disinfect solution. Then, wipe the enclosure with a soft lint.
- 17) Refer to "SAFETY PRECAUTIONS."

## ERROR & REPAIR

Error	Cause	Repair
ERROR PRESSURE	pressure is high with the jammed air hose	When the message is repeated, call for maintenance service.
ERROR CUFF	pressure is low as air leaks	When the message is repeated, call for maintenance service.
ERROR MEASURE	subject moves or speaks while in testing	<ul style="list-style-type: none"><li>- Don't move or speak.</li><li>- When the message is repeated, call for maintenance service.</li></ul>



## AFTER SERVICE

### 1. AFTER SERVICE

- ❗ If there is any problem with the unit, please follow the steps below;
  - ※ Contact our company's Overseas Service Department immediately.  
After gathering the model name, Serial Number, date of purchase and description of the problem, contact our company with information shown below.
  - ※ Try to solve the problem over the phone with the personnel of local service department.  
If the problem cannot be solved over the phone, just return to service department directly.
  - ※ Our company or local distributor will make available on-request circuit diagrams, component part list, descriptions, calibration or other information which will assist your appropriately qualified technical personnel to repair those parts of unit which are designated by our company as repairable.
  - ※ Calibration interval for this device is 2 years.  
To ensure the device's proper and sage operation, please contact our company or distributor periodically for calibration.

How to contact our company

Write us at:

SELVAS Healthcare, Inc.

155, Sinseong-ro, Yuseong-gu, Daejeon, 34109 Republic of Korea

TEL: 82-42-879-3000

FAX: 82-42-864-4462

(You can also contact the following representative or your local distributor)

### 2. PACKING AND TRANSPORT

Our company wraps this device up with the most suitable method to protect it from any impact or damage during shipping and transporting. This device can be damaged during delivery if it is packed with other ways except the one our company uses. Please handle this device carefully without any impact in packing and delivering it.

If this device needs to be transported wrap this device up again and transport it as follows.

- ① Turn off the power of this device.
- ② If peripherals are connected, turn off the power of them and then disconnect each device.
- ③ Disassemble this device in reverse order to assembly.
- ④ Wrap up this device with original packing materials.
- ⑤ Transport it carefully in order not to give a shock to this device.

## SPECIFICATION

Model	ACCUNIQ BP850
Measuring Method	Oscillometric
Display mode	Color LCD Touch display (7inch)
Result Contents	<p>Measuring one arm:            Systolic Blood Pressure, Diastolic Blood Pressure            Mean Blood Pressure, Pulse, Pulse Wave Pattern,            Evaluation of Blood Pressure</p> <p>Measuring both arms:            Systolic Blood Pressure, Diastolic Blood Pressure,            Mean Blood Pressure, Pulse, Pulse Wave Pattern,            Evaluation of Blood Pressure, Inter arm Pressure Difference.</p>
Measuring ranges	Pressure 30~300mmHg, Pulse 30~200beats/minute
Accuracy	Pressure $\pm 3$ mmHg, Pulse With in $\pm 3\%$
Resolving Power	1mmHg
Pressurizing method	DC Motor
Cuff type	Double cuff with automatic pressurization
Pressurizing time	Approx. 20 seconds
Measuring time	Approx. 50 seconds
Printer	High speed thermal printer
Power supply	Input-AC 100~240V~, 50-60Hz, 1.5A Output-DC 12V, 5A, 60VA ADAPTER
Power consumption	96VA
Operating environment	Temperature 10~40°C, Humidity 30~75%
Storage environment	Temperature -10~60°C, Humidity Less than 95%
Data transmission	RS-232C, USB
Dimension	530(W) x 481(D) x 319(H) mm
Weight	Approx. 12kg
Measuring parts	Left arm/Right arm/Both arms

## WARRANTY

### WARRANTY

Item	Automatic Blood Pressure Monitor	Warranty period
Model	ACCUNIQ BP850	1year (main unit only)
Serial NO.		

Date of purchase	Month	Day	Year
Customer	Name:		TEL:
	Address:		
Dealer	Name:		TEL:
	Address:		

Date	Defection	Confirmation

### Note



- When you receive this warranty, make sure that the name of the dealer and the month, day and year of purchase are all completed.
- This warranty will not be reissued, please keep it in a safe place.

## Periodic Check List

Management No. \_\_\_\_\_

Item		Inspection Subject	Requirements	Judgment	Remarks
<b>Visual Check</b>					
Mainframe	1	Enclosure	No scratch, crack, deformation and rust	Pass/Fail	
	2	Labels and panels	No peeling and dust	Pass/Fail	
	3	Keys	No damage	Pass/Fail	
	4	Cuffs	No scratch and damage	Pass/Fail	
Accessories	1	Power cord	No scratch and damage	Pass/Fail	
	2	User manual	Kept in proper place	Pass/Fail	
<b>Mechanical Check</b>					
Mainframe	1	Keys	Smooth operation	Pass/Fail	
	2	Recorder	Smooth operation with no abnormal sound	Pass/Fail	
	3	Cuffs	Smooth operation	Pass/Fail	
Accessories	1	Power cord	Smooth operation and removal	Pass/Fail	
<b>Electrical Check</b>					
Performance	1	Power supply	Screen display upon power-on	Pass/Fail	
	2	Display	No abnormality and flickering	Pass/Fail	
	3	Printing	printing possible	Pass/Fail	
	4	Measurement	Proper measurement	Pass/Fail	
General Judgment				Pass/Fail	
Model		ACCUNIQ BP850		Serial No.	
Installation place			Date of purchase		
Check date		Checked by		Approved by	

Copy this sheet for use

If repair is required, write down so in the Remarks column.

## Daily Check List

Management No. \_\_\_\_\_

Item		Inspection Subject	Requirements	Judgment	Remarks
<b>Visual Check</b>					
Mainframe	1	Enclosure	No scratch, crack, deformation and rust	Pass/Fail	
	2	Labels and panels	No peeling and dust	Pass/Fail	
	3	Keys	No damage	Pass/Fail	
	4	Cuffs	No scratch and damage	Pass/Fail	
Accessories	1	Power cord	No scratch and damage	Pass/Fail	
	2	User manual	Kept in proper place	Pass/Fail	
<b>Mechanical Check</b>					
Mainframe	1	Keys	Smooth operation	Pass/Fail	
	2	Recorder	Smooth operation with no abnormal sound	Pass/Fail	
Accessories	1	Power cord	Smooth operation and removal	Pass/Fail	
<b>Electrical Check</b>					
Performance	1	Power supply	Screen display upon power-on	Pass/Fail	
	2	Display	No abnormality and flickering	Pass/Fail	
	3	Printing	Waveform printing possible	Pass/Fail	
	4	Measurement	Proper measurement	Pass/Fail	
Other	1	Clock	Present date/time	Pass/Fail	
General Judgment				Pass/Fail	
Model		ACCUNIQ BP850		Serial No.	
Installation place			Date of purchase		
Check date		Checked by	Approved by		

Copy this sheet for use

If repair is required, write down so in the Remarks column.



SELVAS Healthcare, Inc.  
HEADQUARTERS:  
155, Sinseong-ro, Yuseong-gu, Daejeon, 34109 Republic of Korea  
TEL:82-42-879-3000 FAX:82-42-864-4462

If the problems continue, call the service center. When you ask for service, the manufacturer's label, serial number, date of original purchase and explanation of malfunction will be required.

**Service center**

**TEL : + 82-42-879-3000**

※ For purposes of improvement, specifications and design are subject to change without notice.



BP850E-20210624 Rev 2.1